



Contact SAMSUNG WORLDWIDE

If you have any questions or comments relating to Samsung products, please contact the SAMSUNG customer care centre.

Country	Customer Care Centre ☎	Web Site
EIRE	0818 717 100	www.samsung.com/ie
U.K	0845 SAMSUNG (7267864)	www.samsung.com



BN68-01416D-00



Plasma TV user manual

imagine the possibilities

Thank you for purchasing this Samsung product.
To receive more complete service, please register
your product at

www.samsung.com/global/register

Model _____ Serial No. _____



User Instructions

◆ Screen Image retention

Do not display a still image (such as on a video game or when hooking up a PC to this PDP) on the plasma monitor panel for more than 2 hours as it can cause screen image retention. This image retention is also known as "screen burn". To avoid such image retention, reduce the degree of brightness and contrast of the screen when displaying a still image.

◆ Height

The PDP can normally operate only under 2000m in height. It might abnormally function at a place over 2000m in height so do not install and operate there.

◆ Heat on the top of the PDP TV

The top side of the product may be hot after long period of use as heat dissipates from the panel through the vent hole in the upper part of the product. This is normal and does not indicate any defect or operation failure of the product. However, children should be prevented from touching the upper part of the product.

◆ The product is making a 'cracking' noise.

A 'cracking' noise may occur when the product contracts or expands due to a change of surrounding environment such as temperature or humidity. This is normal and not a defect of the unit.

◆ Cell Defects

The PDP uses a panel consisting of 1,230,000(SD-level) to 3,150,000(HD-level) pixels which require sophisticated technology to produce. However, there may be few bright or dark pixels on the screen. These pixels will have no impact on the performance of the product.

◆ Avoid operating the TV at temperatures below 5°C(41°F)

◆ A still image displayed too long may cause permanent damage to the PDP Panel.

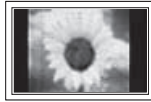

Watching the PDP TV in 4:3 format for a long period of time may leave traces of borders displayed on the left, right and centre of the screen caused by the difference of light emission on the screen. Playing a DVD or a game console may cause similar effect to the screen. Damages caused by the above effect are not covered by the Warranty.

◆ Afterimage on the Screen.

Displaying still images from Video games and PC for longer than a certain period of time may produce partial afterimages. To prevent this effect, reduce the 'brightness' and 'contrast' when displaying still images.

◆ Warranty

- Warranty does not cover any damage caused by image retention.
- Burn-in is not covered by the warranty.

◆ Installation

Be sure to contact an authorized service centre, when installing your set in a location with heavy dust, high or low temperatures, high humidity, chemical substance and where it operates continually such as the airport, the train station etc. Failure to do so may cause a serious damage to your set.

Any functions related to Digital TV (DVB) will only work in countries or areas where DVB-T (MPEG2) digital terrestrial signals are broadcasted. Please confirm with your local dealer if you can receive DVB-T signals. Although this TV set follows the DVB-T specification, maintaining compatibility with the future coming DVB-T digital terrestrial broadcasts is not guaranteed. Several functions may not be available in some countries.

Contact SAMSUNG WORLDWIDE

If you have any questions or comments relating to Samsung products, please contact the SAMSUNG customer care centre. (See back cover for more informations.)

Contents

General Information

- ◆ User Instructions 2
- ◆ Checking Parts 4
- ◆ Using the Stand-Base 4
- ◆ Control Panel 5
- ◆ Connection Panel 6
- ◆ Viewing the Remote Control 8

Operation

- ◆ Switching Your Television On and Off 9
- ◆ Viewing the Menus 9
- ◆ Plug & Play Feature 10
- ◆ Using the TOOLS Button 12
- ◆ Viewing External Signal Sources 12
- ◆ Editing Device Names 13

Channel Control

- ◆ Storing Channels Automatically 13
- ◆ Storing Channels Manually 14
- ◆ Adding / Locking Channels 15
- ◆ Sorting the Stored Channels 16
- ◆ Assigning Names to Channels 16
- ◆ Fine Tuning Channel Reception 17
- ◆ LNA (Low Noise Amplifier) 17

Picture Control

- ◆ Changing the Picture Standard 18
- ◆ Customizing the Picture Settings 18
- ◆ Configuring Detailed Settings on the Picture... 19
- ◆ Picture Options 20
- ◆ Resetting the Picture Settings to the Factory Defaults 22

Sound Control

- ◆ Sound Features 23
- ◆ Selecting the Sound Mode (depending on the model) 24
- ◆ Connecting Headphones (Sold separately) .. 24

Function Description

- ◆ Time Features 25
- ◆ Language / Melody / Light Effect / Entertainment / Energy Saving 26

PC Display

- ◆ Setting up Your PC Software (Based on Windows XP) 27
- ◆ Input Mode (PC) 28
- ◆ Setting the PC 29

Using the DTV Feature

- ◆ Previewing the DTV Menu System 30
- ◆ Displaying Programme Information 31
- ◆ Operating the DTV Menu 32

About Anynet+

- ◆ What is Anynet+? 42
- ◆ Connecting Anynet+ Devices 42
- ◆ Setting Up Anynet+ 43
- ◆ Scanning and Switching between Anynet+ Devices 43
- ◆ Recording 44
- ◆ Listening through a Receiver 45
- ◆ Check Points before Requesting Service 45

Appendix

- ◆ Teletext Feature (depending on the model) .. 46
- ◆ Wall Mount Kit Specifications (VESA) 48
- ◆ Wall- mount adjustment (Sold separately) 49
- ◆ How to assemble the Stand-Base (depending on the model) 50
- ◆ Troubleshooting 51
- ◆ Specifications 52

Symbols



Press



Important



Note

Checking Parts



Owner's Instructions



Remote Control/
AAA Batteries



Power Cord



Cloth-Clean



Registration Card

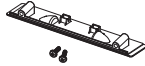

Cover-Bottom / Screws (2ea)
(Refer to page 50)



Ferrite Core for Power Cord



Ferrite Core for S-Video

Sold Separately



Antenna Cable



Component Cables



Audio Cables



PC Cable



Scart Cable



PC Audio Cable



HDMI Cable



HDMI/DVI Cable

➤ **Ferrite Core (Power Cord, S-Video)**

The ferrite cores are used to shield the cables from interference. When connecting a cable, open the ferrite core and clip it around the cable near the plug.

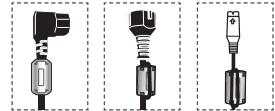

Using the Stand-Base

- ◆ Two or more people should carry the PDP. Never lay the PDP on the floor because of possible damage to the screen. Always keep the PDP upright.
- ◆ The PDP can rotate 20 degrees in right and left directions.

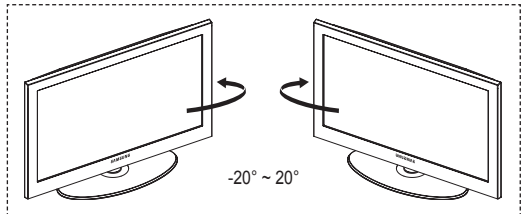

Control Panel

Front (or Side) Panel

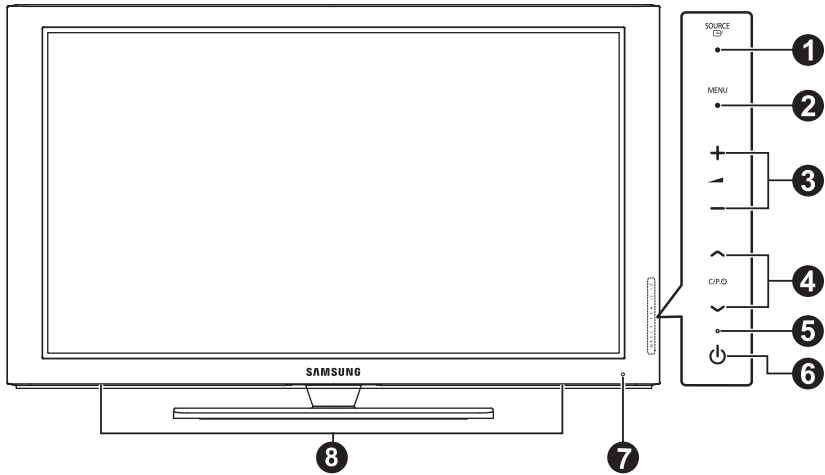

➤ The product colour and shape may vary depending on the model.

1 SOURCE

Toggles between all the available input sources (TV, Ext.1, Ext.2, AV, S-Video, Component, PC, HDMI1, HDMI2, HDMI3 and DTV).

➤ In the on-screen menu, use this button as you would use the **ENTER** button on the remote control.

2 MENU

Press to see an on-screen menu of your TV's features.

3

Press to decrease or increase the volume. In the on-screen menu, use the  buttons as you would use the **◀** and **▶** buttons on the remote control.

4

Press to change channels. In the on-screen menu, use the  buttons as you would use the **▲** and **▼** buttons on the remote control.

5 **Power Indicator**

Blinks and turns off when the power is on and lights up in stand-by mode.

6 POWER

Press to turn the TV on and off.

7 **Remote Control Sensor**

Aim the remote control towards this spot on the TV.

8 **Speakers**

Connection Panel

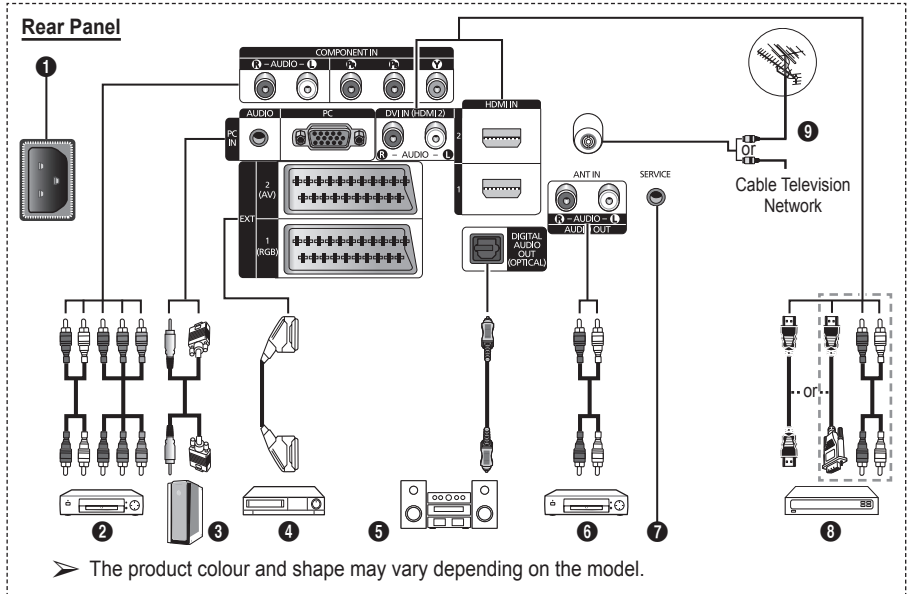

- ◆ Whenever you connect an audio or video system to your set, ensure that all elements are switched off.
- ◆ When connecting an external device, match the colour of the connection terminal to the cable.

1 POWER IN

Connect the supplied power cord.

2 COMPONENT IN

Audio (AUDIO L/R) and video (Y/Pb/Pr) inputs for Component.

3 PC IN(PC) / (AUDIO)

Connect to the video and audio output jack on your PC.

4 EXT 1, EXT 2

Inputs or outputs for external devices, such as VCR, DVD, video game device or video disc players.

5 DIGITAL AUDIO OUT (OPTICAL)

Connect to a Digital Audio Component.

6 Connecting external Audio Devices

Connect RCA audio signals from the TV to an external source, such as Audio equipment.

7 SERVICE

- Connector for service.
- Connect the serial jack between the electro-motion wall mount bracket and your TV when you want to adjust the TV viewing angle using your remote control.

Input/Output Specification

Connector	Input			Output
	Video	Audio(L/R)	RGB	Video + Audio(L/R)
EXT 1	✓	✓	✓	Only TV or DTV output is available.
EXT 2	✓	✓		Output you can choose.

Continued...

8 HDMI IN 1,2

- No additional Audio connection is needed for an HDMI to HDMI connection.
- When using an HDMI/DVI cable connection, you must use the HDMI IN 2 jack.

➤ What is HDMI?

- "High Definition Multimedia interface" allows the transmission of high definition digital video data and multiple channels of digital audio.
- The HDMI/DVI terminal supports DVI connection to an extended device with the appropriate cable (not supplied). The difference between HDMI and DVI is that the HDMI device is smaller in size, has the HDCP (High Bandwidth Digital Copy Protection) coding feature installed, and supports multi-channel digital audio.

DVI IN AUDIO L/R

DVI audio outputs for external devices.

9 DVI IN (HDMI 2) AUDIO R/L

75Ω Coaxial connector for Aerial/Cable Network.

Supported modes for HDMI/DVI and Component

	480i	480p	576i	576p	720p	1080i
HDMI/DVI 50Hz	X	X	X	O	O	O
HDMI/DVI 60Hz	X	O	X	X	O	O
Component	O	O	O	O	O	O

Side Panel

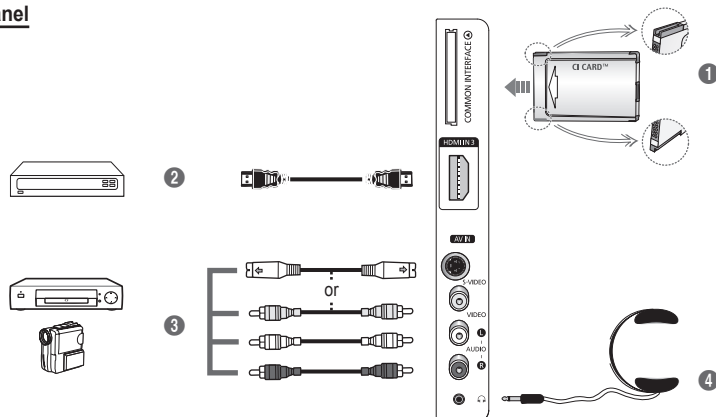

➤ The product colour and shape may vary depending on the model.

1 COMMON INTERFACE Slot

Insert CI (Common Interface) card into the slot. (refer to page 40)

- When not inserting "CI CARD" in some channels, "Scramble Signal" is displayed on the screen.
- The pairing information containing a telephone number, CI CARD ID, Host ID, and other information will be displayed in about 2~3 minutes. If an error message is displayed, please contact your service provider.
- When the channel information configuration has finished, the message "Updating Completed" is displayed, indicating that the channel list is now updated.

➤ Insert the CI-Card in the direction marked on it.

2 HDMI IN 3

Connect to the HDMI jack of a device with HDMI output.

3 S-VIDEO or VIDEO / AUDIO L/R

Video (S-Video or Video) and audio inputs for external devices, such as a camcorder or VCR.

4 Headphones jack

You can connect a set of headphones if you wish to watch a television programme without disturbing the other people in the room.

➤ Prolonged use of headphones at a high volume may damage your hearing.

Viewing the Remote Control

- ◆ The performance of the remote control may be affected by bright light.

- 1 POWER button (turns the TV on and off)
- 2 Selects the TV and DTV mode directly
- 3 Number buttons for direct channel access
- 4 One/Two-digit channel selection
- 5 Temporary sound switch-off
- 6 + Volume increase
- Volume decrease
- 7 Electronic Program Guide (EPG) display
- 8 Use to quickly select frequently used functions.
- 9 Control the cursor in the menu
- 10 Use to see information on the current broadcast
- 13 Press to select the optional display and sound modes for sports, cinema and games.
- 14 VCR/DVD Function (Rewind, Stop, Play/Pause, Fast/Forward)
- 15 Available source selection
- 16 Previous channel
- 17 Next channel
Previous channel
- 18 Displays the main on-screen menu
- 19 Channel control button (Refer to page 15)
- 20 Returns to the previous menu
- 21 Exit the on-screen menu
- 22 Picture size selection

- 23 Use this when connecting a SAMSUNG DMA (Digital Media Adapter) device through an HDMI interface and switching to DMA mode.(The DMA button is optional.) For more information on the operating procedures, refer to the user manual of the DMA. This button is available when "Anynet+(HDMI-CEC)" is "On" (see page 43)
- 24 Digital subtitle display
- 25 Selects the HDMI mode directly

Teletext Functions

(Refer to page 46)

- 2 Exit from the teletext display (depending on the model)
- 7 Teletext store
- 8 Teletext size
- 10 Teletext reveal
- 11 Fasttext topic selection
- 12 Teletext display/mix both teletext information and the normal broadcast
- 15 Teletext mode selection (LIST/FLOF)
- 16 Teletext sub page
- 17 P :Teletext next page
P :Teletext previous page
- 18 Teletext index
- 20 Teletext hold
- 21 Teletext cancel

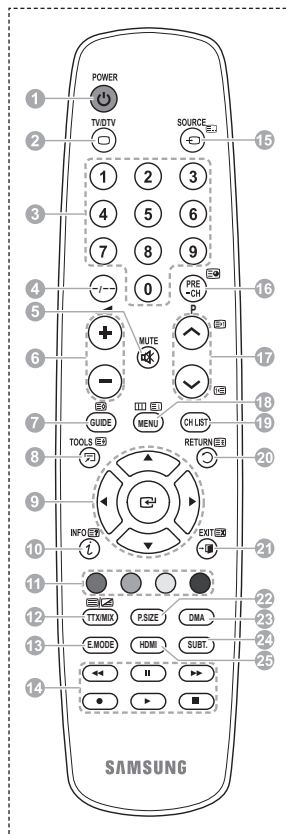

Continued...

Installing Batteries in the Remote Control

- 1 Lift the cover at the back of the remote control upward as shown in the figure.
 - 2 Install two AAA size batteries.
 - ◆ Make sure to match the “+” and “-” ends of the batteries with the diagram inside the compartment.
 - ◆ Do not mix battery types, i.e. alkaline and manganese.
 - 3 Close the cover as shown in the figure.
 - Remove the batteries and store them in a cool and dry place if you won't be using the remote control for a long time. The remote control can be used up to about 23 feet from the TV. (Assuming typical TV usage, the batteries last for about one year.)
- If the remote control doesn't work! Check the following:
1. Is the TV power on?
 2. Are the plus and minus ends of the batteries reversed?
 3. Are the batteries drained?
 4. Is there a power cut, or is the power cord unplugged?
 5. Is there a special fluorescent light or a neon sign nearby?

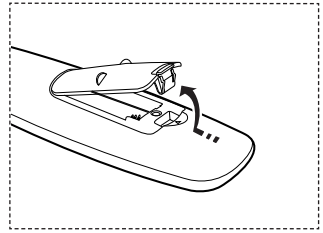

Switching Your Television On and Off

The main lead is attached to the rear of the television.

- 1 Plug the main lead into an appropriate socket.
 - The main voltage is indicated on the rear of the television and the frequency is 50 or 60Hz.
- 2 Press the **⏻** (Power) button (On/Off) on the front of the television or press the **POWER** button on the remote control to switch the television on. The programme that you were watching last is re-selected automatically. If you have not yet stored any channels, no clear picture appears. Refer to “Storing Channels Automatically” on page 13 or “Storing Channels Manually” on page 14.
 - If the television is initially powered on, several basic customer settings proceed automatically. Refer to “Plug & Play Feature” on page 10.
- 3 To switch the television off, press the **⏻** (Power) button (On/Off) on the front of the television or press the **POWER** button on the remote control.
- 4 To switch the TV on, press the **⏻** (Power) button (On/Off) on the front of the TV or press the **POWER** button or **NUMBER** buttons on the remote control.

Viewing the Menus

- 1 Press the **MENU** button.
The main menu is displayed on the screen. Its left side has six icons: **Picture**, **Sound**, **Channel**, **Setup**, **Input**, and **Digital Menu**.
- 2 Press the **▲** or **▼** button to select one of the icons. Press the **ENTER** button to access the icon's sub-menu.
- 3 Press the **▲** or **▼** button to move to items in the menu. Press the **ENTER** button to enter items in the menu.
- 4 Press the **▲/▼/◀/▶** button to change the selected items. Press the **RETURN** button to return to the previous menu.
- 5 Press the **EXIT** button to exit from the menu.

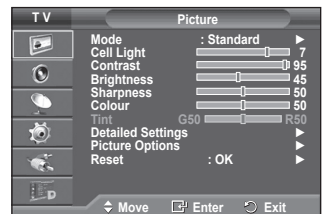

Plug & Play Feature

When the television is initially powered on, several basic customer settings proceed automatically and subsequently. The following settings are available.

- ☛ If you accidentally select the wrong country for your TV, the characters on the screen may be wrongly displayed.
 - ☛ Any functions related to Digital TV (DVB) will only work in countries or areas where DVB-T (MPEG2) digital terrestrial signals are broadcasted. Please confirm with your local dealer if you can receive DVB-T signals. Although this TV set follows the DVB-T specification, maintaining compatibility with the future coming DVB-T digital terrestrial broadcasts is not guaranteed. Several functions may not be available in some countries.
- 1 If the television is in standby mode, press the **POWER** button on the remote control. The message **Start Plug & Play** is displayed. Press the **ENTER** button.
 - 2 The **Language** menu will automatically appear after several seconds.
 - 3 Select the appropriate language by pressing the **▲** or **▼** button. Press the **ENTER** button. The message **Select 'Home Use' when installing this TV in your home.** is displayed.
 - 4 Press the **◀** or **▶** button to select **Store Demo** or **Home Use**, then press the **ENTER** button. The message to check the connected status of the antenna is displayed.
 - The default selection is **Home Use**.
 - We recommend setting the TV to **Home Use** mode for the best picture in your home environment.
 - **Store Demo** mode is only intended for use in retail environments.
 - If the unit is accidentally set to **Store Demo** mode and you want to return to **Home Use** (Standard): Press the Volume button. When the volume OSD is displayed, press and hold the **MENU** button for 5 seconds.
 - 5 Make sure that the antenna is connected to the TV. Press the **ENTER** button. The **Country** menu is displayed.
 - 6 Select your country or area by pressing the **▲** or **▼** button. Press the **ENTER** button. The message **Some DTV functions may not be available. Digital Scan?** is displayed.
 - This function is supported for all countries except for the following countries: France, Germany, Italy, Netherlands, Spain, Switzerland, United Kingdom, Austria.
- If your country supports the DTV functions, the message is not displayed. Then you can follow the instructions from step 12. When the local service provider does not support DTV broadcasting but you choose a DTV supporting country, it enters the DTV Plug & Play but DTV functions may not work properly. When **No** is selected, follow the instructions from step 7 to 10. When **Yes** is selected, follow the instructions from step 11.

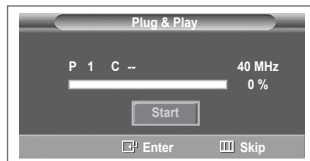
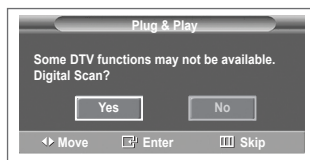
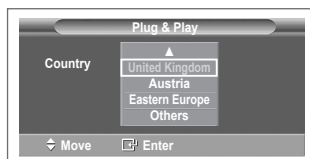
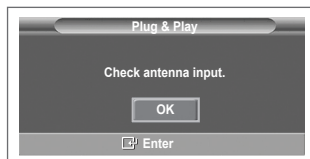
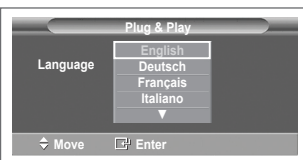

Continued...

- 7 Select **No** pressing the ◀ or ▶ button, then press the **ENTER** button. **Auto Store** menu is displayed.
- 8 Press the **ENTER** button to start search the channels. The channel search will start and end automatically. After all the available channels are stored, **Clock Set** menu is automatically displayed. Press the **ENTER** button.
 - To stop the search before it has finished, press the **ENTER** button with **Stop** selected.
- 9 Press the ◀ or ▶ button to select **Month**, **Day**, **Year**, **Hour**, or **Minute**. Set these by pressing the ▲ or ▼ button.
 - You can set the **Month**, **Day**, **Year**, **Hour**, or **Minute** directly by pressing the numeric buttons on the remote control.
- 10 Press the **ENTER** button to confirm your setting. The message **Enjoy your viewing** is displayed. When you have finished, press the **ENTER** button.
 - Even if the **ENTER** button is not pressed, the message will automatically disappear after several seconds.
- 11 Select **Yes** pressing the ◀ or ▶ button, then press the **ENTER** button. **Auto Store** menu is displayed.
- 12 Press the **ENTER** button to start search the analog channels. The analog channel search will start and end automatically. After all the available analog channels are stored, the screen for searching digital channels is automatically displayed.
 - To stop the search before it has finished, press the **ENTER** button with **Stop** selected.
- 13 Press the **ENTER** button to start search the digital channels. The digital channel search will start and end automatically. After all the available digital channels are stored, the screen to select a time zone is displayed depending on the country.
 - To stop the search before it has finished, press the **ENTER** button with **Stop** selected.
 - If the DTV channel is updated, the Source in the source list of the Input menu is automatically changed to DTV.
 - For detailed descriptions about DTV channel update, refer to page 32 of this manual.
- 14 Press the ▲ or ▼ button to select required time zone, then press the **ENTER** button. The screen for setting the time is displayed. Press the **ENTER** button.
- 15 Press the ◀ or ▶ button to select **Month**, **Day**, **Year**, **Hour**, or **Min**. Set these by pressing the ▲ or ▼ button.
 - You can set the **Month**, **Day**, **Year**, **Hour**, or **Min** directly by pressing the numeric buttons on the remote control.
- 16 Press the **ENTER** button to confirm your setting. The message **Enjoy your viewing** is displayed. When you have finished, press the **ENTER** button.
 - Even if the **ENTER** button is not pressed, the message will automatically disappear after several seconds.

If you want to reset this feature ...

- 1 Press the **MENU** button to display the menu.
- 2 Press the ▲ or ▼ button to select **Setup**, then press the **ENTER** button.
- 3 Press the **ENTER** button again to select **Plug & Play**. The message **Start Plug & Play** is displayed.

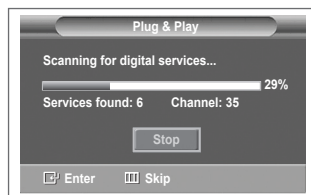
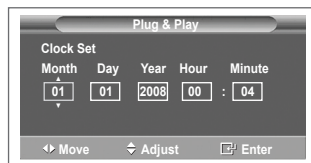

<Spain Only>

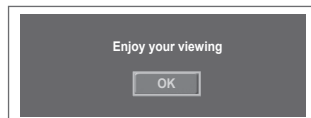

Using the TOOLS Button

You can use the **TOOLS** button to select your frequently used functions quickly and easily. The "Tools" menu changes depending on which external input mode you are viewing.

- 1 Press the **TOOLS** button.
The **Tools** menu will appear.
- 2 Press the **▲** or **▼** button to select a menu, then press the **ENTER** button.
- 3 Press the **▲/▼/◀/▶/ENTER** buttons to display, change, or use the selected items.
For a more detailed description of each function, refer to the corresponding page.

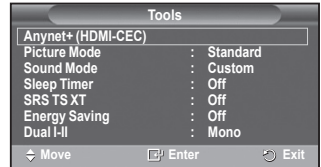

- Anynet+(HDMI-CEC), see page 43
- Picture Mode, see page 18
- Sound Mode, see page 23
- Sleep Timer, see page 25
- SRS TS XT, see page 23
- Energy Saving, see page 27
- Dual I-II, see page 24

Viewing External Signal Sources

You can switch between viewing signals from connected equipment, such as a VCR, DVD, Set-Top Box, and the TV source (broadcast or cable).

- 1 Press the **MENU** button to display the menu.
- 2 Press the **▲** or **▼** button to select **Input**, then press the **ENTER** button.
- 3 Press the **ENTER** button again to select **Source List**.
- 4 Press the **▲** or **▼** button to select the signal source, then press the **ENTER** button.

Available signal sources: **TV, Ext.1, Ext.2, AV, S-Video, Component, PC, HDMI1, HDMI2, HDMI3, DTV**

- You can choose only those external devices that are connected to the TV.
- You can select these options simply by pressing the **SOURCE** button on the remote control.
- To watch television programme again, press the **TV/DTV** button and select the channel number required.
- You can also watch HDMI mode simply by pressing the **HDMI** button on the remote control.

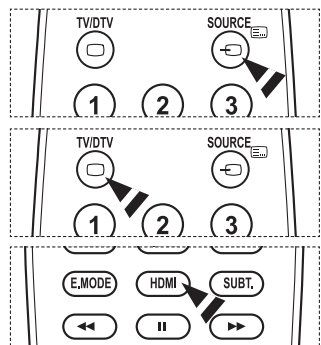
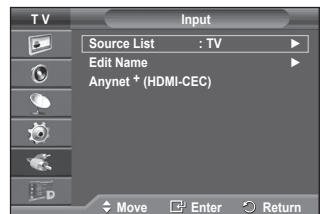

Editing Device Names

You can give a name to the external source.

- 1 Press the **MENU** button to display the menu.
- 2 Press the **▲** or **▼** button to select **Input**, then press the **ENTER** button.
- 3 Press the **▲** or **▼** button to select **Edit Name**, then press the **ENTER** button.
- 4 Press the **▲** or **▼** button to select the external source to be edited, then press the **ENTER** button.
- 5 Select the required device by pressing **▲** or **▼**, then press the **ENTER** button.
Available device names: **VCR, DVD, Cable STB, Satellite STB, PVR STB, AV Receiver, Game, Camcorder, PC, TV, IPTV, Blu-Ray, HD DVD, DMA.**
- 6 Press the **EXIT** button to exit.

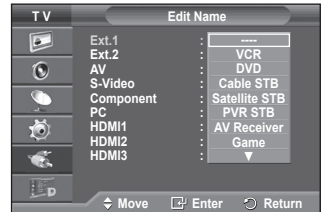
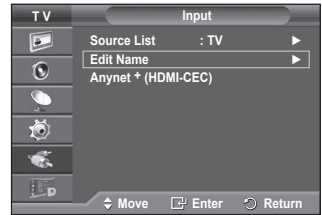

Storing Channels Automatically

➤ Not available in DTV or external input mode.
You can scan for the frequency ranges available to you (availability depends on your country). Automatically allocated programme numbers may not correspond to actual or desired programme numbers. However you can sort numbers manually and clear any channels you do not wish to watch.

- 1 Press the **MENU** button to display the menu.
- 2 Press the **▲** or **▼** button to select **Channel**, then press the **ENTER** button.
- 3 Press the **ENTER** button again. The available countries are listed.
- 4 Select your country by pressing the **▲** or **▼** button, then press the **ENTER** button.
➤ Even though you have changed the country setting in this menu, the country setting for DTV is not changed. Use the Plug & Play function to change the country setting for DTV. (Refer to pages 10 to 11)
- 5 Press the **▲** or **▼** button to select **Auto Store**, then press the **ENTER** button.
- 6 Press the **ENTER** button again to start the search. The search will end automatically.
➤ To stop the search before it has finished, press the **MENU** or the **ENTER** button.



Storing Channels Manually

➤ Not available in DTV or external input mode.

You can store television channels, including those received via cable networks.

When storing channels manually, you can choose:

- ◆ Whether or not to store each of the channels found.
- ◆ The programme number of each stored channel which you wish to identify.

- 1 Press the **MENU** button to display the menu.
- 2 Press the **▲** or **▼** button to select **Channel**, then press the **ENTER** button.
- 3 Press the **▲** or **▼** button to select **Manual Store**, then press the **ENTER** button.
- 4 Select the required option by pressing the **▲** or **▼** button, then press the **ENTER** button.
- 5 When you are satisfied with your setting, press the **ENTER** button.
- 6 Press the **EXIT** button to exit.

- ◆ **Programme** (Programme number to be assigned to a channel)
 - Press the **▲** or **▼** button until you find the correct number.
 - You can also select the channel number directly by pressing the numeric buttons (0~9).

- ◆ **Colour System: Auto/PAL/SECAM/NTSC4.43**

- Press the **▲** or **▼** button to select the required colour standard.

- ◆ **Sound System: BG/DK/I/L**

- Press the **▲** or **▼** button to select the required sound standard.

- ◆ **Channel** (When you know the number of the channel to be stored)

- Press the **▲** or **▼** button to select **C** (Air channel) or **S** (Cable channel).
- Press the **▶** button, then press the **▲** or **▼** button to select the required number.
- You can also select the channel number directly by pressing the numeric buttons (0~9).
- If there is abnormal sound or no sound, re-select the sound standard required.

- ◆ **Search** (When you do not know the channel numbers)

- Press the **▲** or **▼** button to start the search.
- The tuner scans the frequency range until the first channel or the channel that you selected is received on the screen.

- ◆ **Store** (When you store the channel and associated programme number)

- Set to **OK** by pressing the **ENTER** button.

Channel mode

- ◆ **P** (Programme mode): When completing tuning, the broadcasting stations in your area have been assigned to position numbers from P00 to P99. You can select a channel by entering the position number in this mode.
- ◆ **C** (Air channel mode): You can select a channel by entering the assigned number to each air broadcasting station in this mode.
- ◆ **S** (Cable channel mode): You can select a channel by entering the assigned number for each cable channel in this mode.

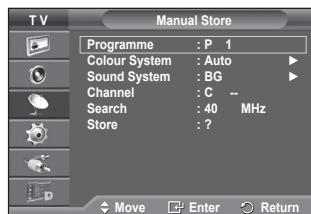

Adding / Locking Channels

➤ Not available in DTV or external input mode.

Using the Channel Manager, you can conveniently lock or add channels.

- 1 Press the **MENU** button to display the menu.
- 2 Press the **▲** or **▼** button to select **Channel**, then press the **ENTER** button.
- 3 Press the **▲** or **▼** button to select **Channel Manager**, then press the **ENTER** button.

◆ Adding channels

Using the Channel List, you can add channels.

- 4 Select **Channel List** by pressing the **ENTER** button.
- 5 Move to the (⊕) field by pressing the **▲/▼/◀/▶** buttons, select a channel to be added, and press the **ENTER** button to add the channel.
 - If you press the **ENTER** button again, the (✓) symbol next to the channel disappears and the channel is not added.

◆ Locking channels

This feature allows you to prevent unauthorized users, such as children, from watching unsuitable programmes by muting out video and audio.

- 6 Press the **▲** or **▼** button to select **Child Lock**, then press the **ENTER** button.
 - 7 Select **On** by pressing the **▲** or **▼** button, then press the **ENTER** button.
 - 8 Press the **▲** or **▼** button to select **Channel List**, then press the **ENTER** button.
 - 9 Move to the (🔒) field by pressing the **▲/▼/◀/▶** buttons, select a channel to be locked, and press the **ENTER** button.
 - If you press the **ENTER** button again, the (✓) symbol next to the channel disappears and the channel lock is canceled.
 - A blue screen is displayed when Child Lock is activated.
 - 10 Press the **EXIT** button to exit.
- You can select these options simply by pressing the **CH LIST** button on the remote control.

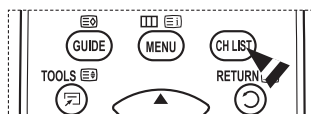
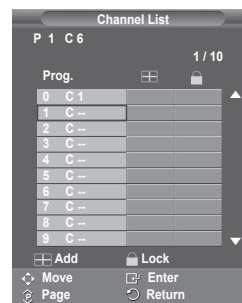

Sorting the Stored Channels

➤ Not available in DTV or external input mode.

This operation allows you to change the programme numbers of the stored channels.

This operation may be necessary after using the auto store.

- 1 Press the **MENU** button to display the menu.
- 2 Press the **▲** or **▼** button to select **Channel**, then press the **ENTER** button.
- 3 Press the **▲** or **▼** button to select **Sort**, then press the **ENTER** button.
- 4 Select the channel that you wish to move by pressing the **▲** or **▼** button, then press the **ENTER** button.
- 5 Select the number of the programme to which the channel is to be moved by pressing the **▲** or **▼** button. Press the **ENTER** button. The channel is moved to its new position and all other channels are shifted accordingly.
- 6 Repeat steps 4 to 5 until you have moved all the channels to the required programme numbers.
- 7 Press the **EXIT** button to exit.

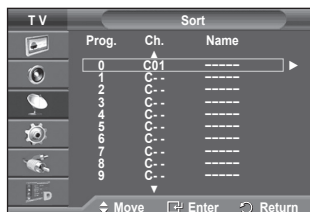

Assigning Names to Channels

➤ Not available in DTV or external input mode.

Channel names will be assigned automatically when channel information is broadcast. These names can be changed, allowing you to assign new names.

- 1 Press the **MENU** button to display the menu.
- 2 Press the **▲** or **▼** button to select **Channel**, then press the **ENTER** button.
- 3 Press the **▲** or **▼** button to select **Name**, then press the **ENTER** button.
- 4 Press the **▲** or **▼** button to select the channel to be assigned to a new name, then press the **ENTER** button.
- 5 Press the **▲** or **▼** button to select a letter, a number, or a symbol (Results in this sequence: A~Z, 0~9, +, -, *, /, blank). Move on to the previous or next letter by pressing the **◀** or **▶** button, then press the **ENTER** button.
- 6 Repeat steps 4 to 5 for each channel to be assigned to a new name.
- 7 Press the **EXIT** button to exit.

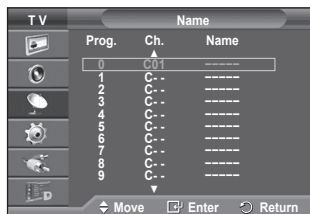

Fine Tuning Channel Reception

➤ Not available in DTV or external input mode.

If the reception is clear, you do not have to fine tune the channel, as this is done automatically during the search and store operation.

If the signal is weak or distorted, you may have to fine tune the channel manually.

- 1 Press the **MENU** button to display the menu.
- 2 Press the **▲** or **▼** button to select **Channel**, then press the **ENTER** button.
- 3 Press the **▲** or **▼** button to select **Fine Tune**, then press the **ENTER** button.
- 4 To obtain a sharp, and clear picture and good sound quality, press the **◀** or **▶** button until you reach the optimal setting. Press the **ENTER** button.
 - Press the **INFO** button. Fine Tune Store will change the colour of the Channel OSD (On Screen Display) from White to Red and add the “**” mark.
 - To reset the fine tuning to **0**, select **Reset** by pressing the **▲** or **▼** button. Press the **ENTER** button.
- 5 Press the **EXIT** button to exit.

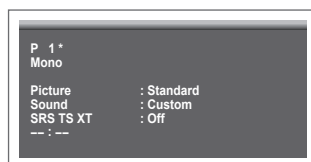
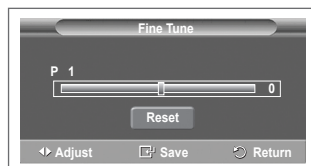

LNA (Low Noise Amplifier)

This function is very useful in the situation that the TV is used in weak signal.

LNA amplifies the TV signal in the weak signal area, a low-noise preamplifier boosts the incoming signal.

- 1 Press the **MENU** button to display the menu.
- 2 Press the **▲** or **▼** button to select **Channel**, then press the **ENTER** button.
- 3 Press the **▲** or **▼** button to select **LNA**, then press the **ENTER** button.
- 4 Select **Off** or **On** by pressing the **▲** or **▼** button, then press the **ENTER** button.
- 5 Press the **EXIT** button to exit.
 - Depending on areas, factory mode of LNA, will be set up as On or Off.



Changing the Picture Standard

You can select the type of picture which best corresponds to your viewing requirements.

- 1 Press the **MENU** button to display the menu.
- 2 Press the **ENTER** button to select **Picture**.
- 3 Press the **ENTER** button again to select **Mode**.
- 4 Select the required mode by pressing the **▲** or **▼** button, then press the **ENTER** button.

Available modes: **Dynamic**, **Standard**, **Movie**

➤ The settings values may vary depending on the input source.

- 5 Press the **EXIT** button to exit.
 - ◆ Choose **Dynamic** for viewing the TV during the day or when there is bright light in the room.
 - ◆ Choose **Standard** for general TV watching mode.
 - ◆ Choose **Movie** when viewing the movie.

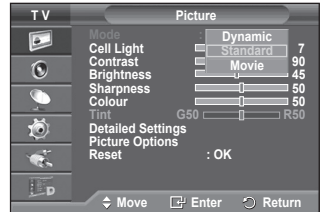
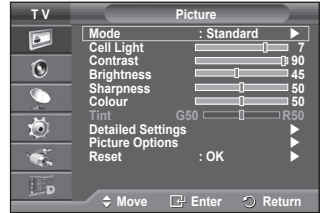

Easy Setting

- 1 Press the **TOOLS** button on the remote control.
- 2 Press the **▲** or **▼** button to select **Picture Mode**.
- 3 Press the **◀** or **▶** button to select the required option.

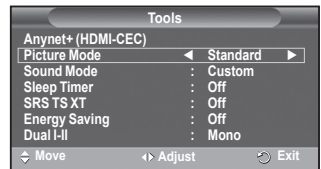

Customizing the Picture Settings

Your television has several setting options that allow you to control the picture quality.

- 1 Press the **MENU** button to display the menu.
- 2 Press the **ENTER** button to select **Picture**.
- 3 Press the **ENTER** button again to select **Mode**.
- 4 Select the required mode by pressing the **▲** or **▼** button, then press the **ENTER** button.

Available modes: **Dynamic**, **Standard**, **Movie**
- 5 Select the required option by pressing the **▲** or **▼** button, then press the **ENTER** button.
- 6 When you are satisfied with your setting, press the **ENTER** button.
- 7 Press the **EXIT** button to exit.

◆ Cell Light - Contrast – Brightness – Sharpness – Colour – Tint

- In Analog TV, Ext., AV, S-Video modes of the PAL system, you cannot use the Tint Function.
- In PC mode, you can only make changes to **Cell Light**, **Contrast**, and **Brightness**. Press the **◀** or **▶** button until you reach the optimal setting.

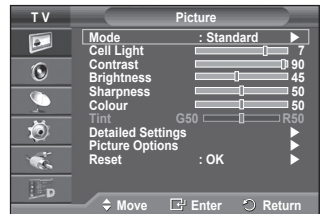

Configuring Detailed Settings on the Picture

You can set detailed picture settings.

- 1 Press the **MENU** button to display the menu.
- 2 Press the **ENTER** button to select **Picture**.
- 3 Press the **▲** or **▼** button to select **Detailed Settings**, then press the **ENTER** button.
- 4 Select the required option by pressing the **▲** or **▼** button, then press the **ENTER** button.

Available options: **Black Adjust**, **Dynamic Contrast**, **Gamma**, **Colour Space**, **White Balance**, **Flesh Tone**, **Edge Enhancement**

- 5 When you are satisfied with your setting, press the **ENTER** button.
- 6 Press the **EXIT** button to exit.

➤ **Detailed Settings** is available in **Standard** or **Movie** mode.

➤ In PC mode, you can only make changes to **Dynamic Contrast**, **Gamma** and **White Balance** from among the **Detailed Settings** items.

◆ **Black Adjust: Off/Low/Medium/High**

You can directly select the black level on the screen to adjust the screen depth.

◆ **Dynamic Contrast: Off/Low/Medium/High**

You can adjust the screen contrast so that the optimal contrast is provided.

◆ **Gamma: -3 ~ +3**

You can adjust the middle brightness of pictures.

Press the **◀** or **▶** button until you reach the optimal setting.

◆ **Colour Space: Auto/Native/Custom**

Colour space is a colour matrix composed of red, green and blue colours.

Select your favorite colour space to experience the most natural colour.

- **Auto:** Auto Colour Space automatically adjusts to the most natural colour tone based on program sources.

- **Native:** Native Colour Space offers deep and rich colour tone.

- **Custom:** Adjusts the colour range to suit your preference. (see "Customizing the Colour Space")

Customizing the Colour Space

Colour: Red/Green/Blue/Yellow/Cyan/Magenta

Adjusts the Colour range to suit your preference.

Colour is available when **Colour Space** is set to Custom.

Press the **▲** or **▼** button to select **Red**, **Green**, **Blue**, **Yellow**, **Cyan** or **Magenta**.

Press the **ENTER** button.

- **Red/Green/Blue:** In Colour, you can adjust the RGB values for the selected colour.

Press the **▲** or **▼** button to select **Red**, **Green** or **Blue** to change it. Press the **ENTER** button.

Press the **◀** or **▶** button to decrease or increase the value of a particular item.

Press the **ENTER** button.

- **Reset:** Resets the colour space to the default values.

◆ **White Balance: R-Offset/G-Offset/B-Offset/R-Gain/G-Gain/B-Gain/Reset**

You can adjust the color temperature for more natural picture colors.

R-Offset/G-Offset/B-Offset/R-Gain/G-Gain/B-Gain: Changing the adjustment value will refresh the adjusted screen.

Select the required option by pressing the **▲** or **▼** button, then press the **ENTER** button. Press the **◀** or **▶** button until you reach the optimal setting.

Reset: The previously adjusted white balance will be reset to the factory defaults.

◆ **Flesh Tone: -15~+15**

You can emphasize the pink tone in the picture.

Press the **◀** or **▶** button until you reach the optimal setting.

➤ Changing the adjustment value will refresh the adjusted screen.

◆ **Edge Enhancement: Off/On**

You can emphasize object boundaries.

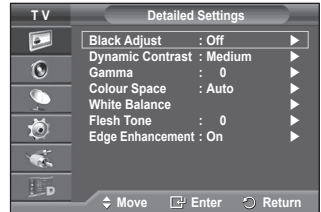
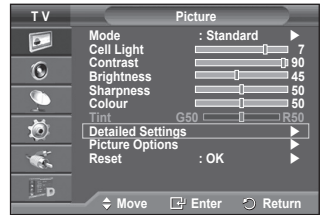

Picture Options

You can set detailed picture settings.

- 1 Press the **MENU** button to display the menu.
 - 2 Press the **ENTER** button to select **Picture**.
 - 3 Press the **▲** or **▼** button to select **Picture Options**, then press the **ENTER** button.
 - 4 Select the required option by pressing the **▲** or **▼** button, then press the **ENTER** button.
 - 5 When you are satisfied with your setting, press the **ENTER** button.
 - 6 Press the **EXIT** button to exit.
- In **PC** mode, you can only make changes to the **Color Tone**, **Size** and **Screen Burn Protection** from among the items in **Picture Options**.

◆ **Colour Tone: Cool2/Cool1/Normal/Warm1/Warm2**

- When the picture mode is set to **Dynamic** or **Standard**, **Warm1** and **Warm2** cannot be selected.

◆ **Size: Auto Wide/16:9/Wide Zoom/Zoom/4:3/Just Scan**

You can select the picture size which best corresponds to your viewing requirements.

- **Auto Wide:** Expanding and pulling up the picture from 4:3 to 16:9 ratio.
- **16:9:** Sets the picture to 16:9 wide mode.
- **Wide Zoom:** Magnify the size of the picture more than 4:3. Move the screen up/down using the **▲** or **▼** button after selecting the  by pressing the **▶** or **ENTER** button.
- **Zoom:** Magnify the size of the picture vertically on screen.
- **4:3:** Sets the picture to **4:3** normal mode.
- **Just Scan:** Use the function to see the full image without any cutoff when HDMI (720p/1080i), Component (1080i) or DTV (1080i) signals are input.

After selecting Just Scan in HDMI (1080i) or Component (1080i) mode:



Press the **◀** or **▶** button to select , then press the **ENTER** button.

Press the **▲**, **▼**, **◀** or **▶** button to move the picture up, down, left and right.

Reset: Press the **◀** or **▶** button to select **Reset**, then press the **ENTER** button. You can initialize the setting.

- With the HDMI Just Scan picture size, depending on the AV devices, the screen may be cut off or a specific colour appears on the screen.
 - For an HDMI (1080p) connection of 24, 25, 30, 50, and 60 Hz, and for a Component (1080p) connection of 50 and 60Hz, only the input source is supported.
- You can change the picture size simply by pressing the **P.SIZE** button on the remote control.
- Depending on the input source, the picture size options may vary.
- The items available may differ depending on the selected mode.
- **Auto Wide** function is available only in **TV**, **DTV**, **Ext.1**, **Ext.2**, **AV**, and **S-Video** mode.
- Settings can be adjusted and stored for each external device you have connected to an input of the TV.
- In PC Mode, only "16:9" and "4:3" mode can be adjusted.

Positioning and Sizing the screen using Zoom

- ◆ Resizing the screen using the **Zoom** enables the positioning and sizing of the screen to up/down direction using the **▲** or **▼** button as well as the screen size.
- ◆ Move the screen up/down using the **▲** or **▼** button after selecting the  by pressing the **◀** or **▶** button.
- ◆ Resize the screen vertically using the **▲** or **▼** button after selecting the  by pressing the **◀** or **▶** button.

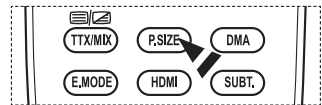
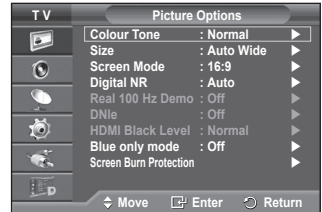
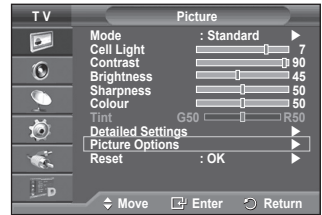

◆ **Screen Mode: 16:9/Wide Zoom/Zoom/4:3**

When setting the picture size to Auto Wide in a 16:9 wide TV, you can determine the picture size you want to see the 4:3 WSS (Wide Screen Service) image or nothing. Each individual European country requires different picture size so this function is intended for users to select it.

- **16:9:** Sets the picture to 16:9 wide mode.
- **Wide Zoom:** Magnify the size of the picture more than 4:3.
- **Zoom:** Magnify the size of the picture vertically on screen.
- **4:3:** Sets the picture to 4:3 normal mode.
- This function is available in **Auto Wide** mode.
- This function is not available in **Component** or **HDMI** mode.

◆ **Digital NR: Off/Low/Medium/High/Auto**

If the signal received by the television is weak, you can activate this feature to reduce any static and ghosting that may appear on the screen.

- When the signal is weak, select one of the other options until the best picture is displayed.

◆ **Real 100 Hz Demo: Off/On**

You can get a clear distinction between "Real 100Hz" and 50Hz, especially when watching sports. Therefore, when seeing a paused or static image, you will not be able to distinguish between "Real 100Hz" and 50Hz.

◆ **DNLe: Off/Demo/On**

This TV includes the DNLe function so as to provide a high visual quality. If you set DNLe to on, you can view the screen with the DNLe feature activated. If you set the DNLe to Demo, you can view the applied DNLe and normal pictures on the screen, for demonstration purposes. Using this function, you can view the difference in the visual quality.

- **DNLe™ (Digital Natural Image engine) DNLe**
This feature brings you more detailed image with 3D noise reduction, detail enhancement, contrast enhancement and white enhancement. New image compensation Algorithm gives brighter, clearer, more detailed image to you. DNLe™ technology will fit every signal into your eyes.
- This cofunction is not available in **PC** mode.
- DNLe is only available in **Dynamic** mode.

◆ **HDMI Black Level: Normal/Low**

Using this function, you can adjust the image quality when the screen burn (appearance of black level, low contrast, low color, etc.) is encountered by the HDMI input for RGB limited range (16 to 235).

- This function is active only when the external input connects to HDMI(RGB signals).

◆ **Blue Only Mode: Off/On**

This function is for AV device measurement experts. This function displays the blue signal only by removing the red and green signals from the video signal so as to provide a Blue Filter effect that is used to adjust the Colour and Tint of video equipment such as DVD players, Home Theaters, etc. Using this function, you can adjust the Colour and Tint to preferred values appropriate to the signal level of each video device using the Red/Green/Blue/Cyan/Magenta/Yellow Colour Bar Patterns, without using an additional Blue Filter.

- **Blue Only Mode** is available when the picture mode is set to **Movie** or **Standard**.

◆ **Screen Burn Protection**

To reduce the possibility of screen burn, this unit is equipped with screen burn prevention technology. This technology enables you to set picture movement up/down (Vertical Line) and side to side (Horizontal Dot). The Time setting allows you to program the time between movement of the picture in minutes.

- **Pixel Shift:** Using this function, you can minutely move pixels on the PDP in horizontal or vertical direction to minimize after image on the screen.
 - Set **Pixel Shift** to **On** by pressing the ▲ or ▼ button, then press the **ENTER** button.
 - Select the required option by pressing the ▲ or ▼ button, then press the **ENTER** button.

Available options: **Horizontal Dot, Vertical Line, Time**

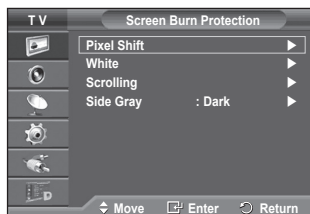
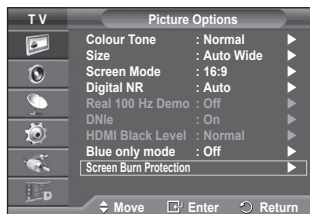
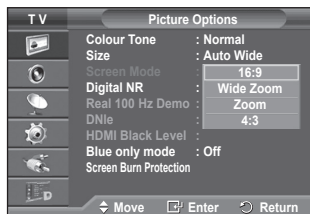

Continued...

- Optimum condition for pixel shift;

	PC	TV/Ext/AV/Component/ HDMI/DTV
Horizontal Dot	1	2
Vertical Line	1	2
Time (minute)	2	2 min

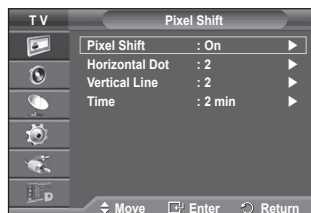

- The Pixel Shift value may differ depending on the monitor size (inches) and mode.
 - **White:** This function helps remove after images on the screen by changing the colour of pixels to white. Use this function when there are remaining after images or symbols on the screen especially when you displayed a still image on the screen for a long time.
 - **Scrolling:** This function helps remove after images on the screen by moving all the pixels on the PDP according to a pattern. Use this function when there are remaining after images or symbols on the screen especially when you displayed a still image on the screen for a long time.
 - **Side Gray:** When you watch TV with the screen ratio of 4:3, the screen is prevented from any damage by adjusting the white balance on both extreme left and right sides.
 - Dark:** When you set the screen ratio to 4:3, it darkens the left and right sides.
 - Light:** When you set the screen ratio to 4:3, it brightens the left and right sides.
- To remove after images on the screen, use either **White** or **Scrolling** function. Although both of the two functions remove after images on the screen, **Scrolling** is more effective.
- The after image removal function has to be executed for a long time (approximately 1 hour) to effectively remove after images on the screen. If after image is not improved after the execution of the function, repeat the function again.
- Press any button on the remote control to cancel this feature.

Resetting the Picture Settings to the Factory Defaults

You can set detailed picture settings.

- 1 Press the **MENU** button to display the menu.
- 2 Press the **ENTER** button to select **Picture**.
- 3 Press the **▲** or **▼** button to select **Reset**, then press the **ENTER** button.
- 4 Press the **▲** or **▼** button to select **OK** or **Cancel** then press the **ENTER** button.
 - Each mode can be reset.

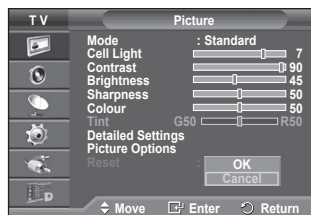

Sound Features

- 1 Press the **MENU** button to display the menu.
- 2 Press the **▲** or **▼** button to select **Sound**, then press the **ENTER** button.
- 3 Select the required option by pressing the **▲** or **▼** button, then press the **ENTER** button.

Available options: **Mode, Equalizer, SRS TS XT, Auto Volume, TV Speaker**

- 4 When you are satisfied with your setting, press the **ENTER** button.
- 5 Press the **EXIT** button to exit.

- ◆ **Mode: Standard/Music/Movie/Speech/Custom**
You can select the type of special sound effect to be used when watching a given broadcast.

Easy Setting

- 1 Press the **TOOLS** button on the remote control.
- 2 Press the **▲** or **▼** button to select **Sound Mode**.
- 3 Press the **◀** or **▶** button to select the required option.

- ◆ **Equalizer: Balance/100Hz/300Hz/1kHz/3kHz/10kHz**
The television has several settings which allow you to control the sound quality.
➤ If you make any changes to these settings, the sound mode is automatically switched to **Custom**.

- ◆ **SRS TS XT: Off/On**

TruSurround XT is a patented SRS technology that solves the problem of playing 5.1 multichannel content over two speakers.

TruSurround delivers a compelling, virtual surround sound experience through any two-speaker playback system, including internal television speakers. It is fully compatible with all multichannel formats.

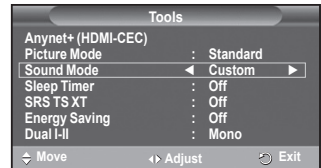
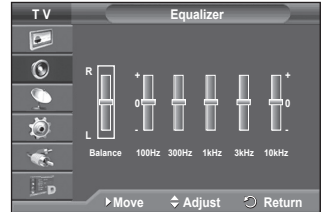
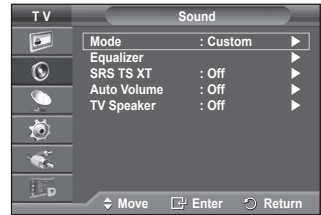

TruSurround XT, SRS and (●) Symbol are trademarks of SRS Labs, Inc.
TruSurround XT technology is incorporated under license from SRS Labs, Inc.

Easy Setting

- 1 Press the **TOOLS** button on the remote control.
- 2 Press the **▲** or **▼** button to select **SRS TS XT**.
- 3 Press the **◀** or **▶** button to select **Off** or **On**.

- ◆ **Auto Volume: Off/On**

Each broadcasting station has its own signal conditions, and so it is not easy to adjust the volume every time the channel is changed. This feature lets you automatically adjust the volume of the desired channel by lowering the sound output when the modulation signal is high or by raising the sound output when the modulation signal is low.

- ◆ **TV Speaker: Off/On**

If you want to hear the sound through separate speakers, cancel the internal amplifier.

- The **▲**, **▼** and **MUTE** buttons do not operate when the TV Speaker is set to **Off**.
- When **TV Speaker** is set to **Off**, the Sound menus cannot be adjusted.

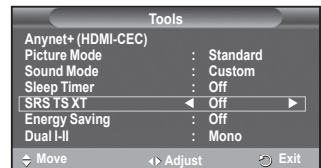

Selecting the Sound Mode (depending on the model)

The DUAL I-II button displays/controls the processing and output of the audio signal. When power is switched on, the mode is automatically preset to either "DUAL-I" or "Stereo", depending on the current transmission.

Easy Setting

- 1 Press the **TOOLS** button on the remote control.
- 2 Press the **▲** or **▼** button to select **Dual I-II**.
- 3 Press the **◀** or **▶** button to select the required option.

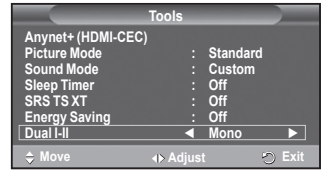

	Type of broadcast	On-screen indication		
NICAM Stereo	Regular broadcast (Standard audio)	Mono (Normal use)		
	Regular + NICAM Mono	NICAM	↔	Mono (Normal)
	NICAM Stereo	NICAM stereo	↔	Mono (Normal)
	NICAM DUAL-I/II	NICAM dual-1	→	NICAM dual-2 → Mono (Normal)
A2 Stereo	Regular broadcast (Standard audio)	Mono (Normal use)		
	Bilingual or DUAL-I/II	Dual I	↔	Dual II
	Stereo	Stereo	↔	Mono (Forced mono)

- ◆ If the receiving conditions deteriorate, listening will be easier if the mode is set to **Mono**.
- ◆ If the stereo signal is weak and automatic switching occurs, switch to **Mono**.
- ◆ This function is only available in Analog TV mode.

Connecting Headphones (Sold separately)

You can connect a set of headphones to your set if you wish to watch a TV program without disturbing other people in the room.

- When you insert the head set jack into the corresponding port, you can operate only "Auto Volume" in Sound menu.
- Prolonged use of headphones at a high volume may damage your hearing.
- You will not hear sound from the speakers when you connect headphones to the TV.
- The headphone volume and TV volume are adjusted separately.

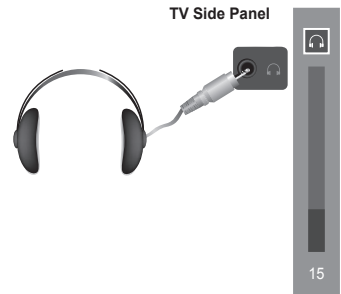

Time Features

- 1 Press the **MENU** button to display the menu.
- 2 Press the **▲** or **▼** button to select **Setup**, then press the **ENTER** button.
- 3 Press the **▲** or **▼** button to select **Time**, then press the **ENTER** button.
- 4 Select the required option by pressing the **▲** or **▼** button, then press the **ENTER** button.
Available options: **Clock Set**, **Sleep Timer**, **Timer 1**, **Timer 2**, **Timer 3**
- 5 When you are satisfied with your setting, press the **ENTER** button.
- 6 Press the **EXIT** button to exit.

◆ Clock Set

You can set the television clock so that the current time is displayed when pressing the **INFO** button on the remote control. You must also set the time if you wish to use the automatic on or off timers.

- Press the **◀** or **▶** button to select **Month**, **Day**, **Year**, **Hour**, or **Minute**. Set these by pressing the **▲** or **▼** button.
- You can set the **Month**, **Day**, **Year**, **Hour**, or **Minute** directly by pressing the numeric buttons on the remote control.
- In the event of a power interruption or the set being turned off at the supply, the settings for the Clock will be lost.

◆ Sleep Timer

You can select a time period of between 30 and 180 minutes after which the television automatically switches to standby mode.

- Select the preset time interval (**Off**, **30**, **60**, **90**, **120**, **150**, or **180**) for staying on by pressing the **▲** or **▼** button.

Easy Setting

- 1 Press the **TOOLS** button on the remote control.
- 2 Press the **▲** or **▼** button to select **Sleep Timer**.
- 3 Press the **◀** or **▶** button to select the minute, then press the **ENTER** button.

◆ Timer 1 / Timer 2 / Timer 3

You can set the **On/Off** timers so that the television will switch on or off automatically at the time you select.

☛ You must set the clock first.

- Press the **◀** or **▶** button to select the required item below. Press the **▲** or **▼** button to adjust to the setting satisfied.

On Time : Select hour, minute, and **On/Off**. (To activate timer with the setting satisfied, set to **On**.)

Off Time : Select hour, minute, and **On/Off**. (To activate timer with the setting satisfied, set to **On**.)

Repeat : Select **Once**, **Everyday**, **Mon-Fri**, **Mon-Sat**, or **Sat-Sun**.

Volume : Select the required volume level.

- You can set the hour, minute, directly by pressing the number buttons on the remote control.

☛ Auto Power Off

When you set the timer "On", the TV will eventually turn off, if no controls are operated for 3 hours after the TV was turned on by timer. This function is only available in timer "On" mode and prevents overheating, which may occur if a TV is on for too long time.

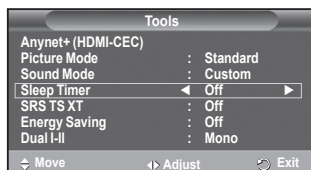
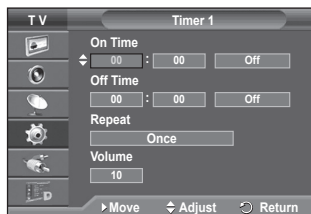
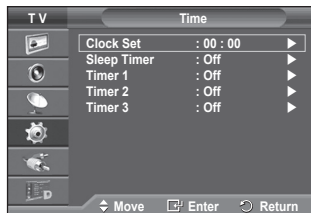

Language / Melody / Light Effect / Entertainment / Energy Saving

- 1 Press the **MENU** button to display the menu.
- 2 Press the **▲** or **▼** button to select **Setup**, then press the **ENTER** button.
- 3 Select the required option by pressing the **▲** or **▼** button, then press the **ENTER** button.

Available options: **Language, Melody, Light Effect, Entertainment, Energy Saving**

- 4 When you are satisfied with your setting, press the **ENTER** button.
- 5 Press the **EXIT** button to exit.

◆ Language

It is variable depending on the model. When you start using the television for the first time, you must select the language which will be used for displaying menus and indications.

◆ Light Effect: Off/In Standby/In Watching TV/Always

You can turn on/off the blue LED on the front of TV according to the situation. Use it for saving power or when the LED dazzles your eyes.

- **Off**: The blue LED is always off.
- **In Standby**: The blue LED lights while in Standby mode and it turns off when your TV is turned on.
- **In Watching TV**: The blue LED lights when watching TV and it turns off when your TV is turned off.
- **Always**: The blue LED always lights.

➤ Set the Light Effect to Off to reduce the power consumption.

◆ Melody: Off/Low/Medium/High

The TV power on/off melody sound can be adjusted.



Manufactured under license from Dolby Laboratories.
Dolby and the double-D symbol are trademarks of Dolby Laboratories.

◆ Entertainment: Off/Sports/Cinema/Game

Entertainment mode enables you to select the optimal display and sound for sports, cinema and games.

- **Off**: Switches the **Entertainment** function off.
- **Sports**: Provides the optimal picture and sound quality for sports.
- **Cinema**: Provides the optimal picture and sound quality for movie watching.

You can experience a richer picture and enhanced sound.

- **Game**: Provides the optimal picture and sound quality for games. This mode accelerates the playing speed when using an external game console connected to the TV.

➤ If you set any of the three Entertainment modes to On, the settings will be locked and can not be adjusted. If you want to make Picture and Sound mode adjustments, the Entertainment mode must be turned off.

➤ The Entertainment settings are saved for each input source.

Continued...

◆ **Energy Saving: Off/Low/Medium/High**

This feature adjusts the screen brightness depending on the surrounding lighting conditions.

- **Off:** Switches off the Energy Saving mode.
- **Low:** Operates in standard mode regardless of the surrounding illumination.
- **Medium:** Enters Medium power saving mode regardless of the surrounding illumination.
- **High:** Enters maximum power saving mode regardless of the surrounding illumination.

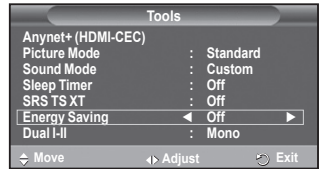

Easy Setting

- 1 Press the **TOOLS** button on the remote control.
- 2 Press the ▲ or ▼ button to select **Energy Saving**.
- 3 Press the ◀ or ▶ button to select the required option.

Setting up Your PC Software (Based on Windows XP)

The Windows display-settings for a typical computer are shown below. But the actual screens on your PC will probably be different, depending upon your particular version of Windows and your particular video card. But even if your actual screens look different, the same, basic set-up information will apply in almost all cases. (If not, contact your computer manufacturer or Samsung Dealer.)

- 1 Right click the mouse on the Windows Desktop, then click on **Properties**. The **Display Properties** will be displayed.
- 2 Click on **Settings** tab, then set the Display Mode with reference to the Display Modes Table. You do not need to change the Colours settings.
- 3 Click on **Advanced**. A new settings dialog box will be displayed.
- 4 Click on the **Monitor** tab, then set the **Screen refresh rate** with reference to the Display Modes Table. Set the Vertical Frequency and Horizontal Frequency individually if you can do so instead of setting the **Screen refresh rate**.
- 5 Click on **OK** to close the window, then Click on **OK** button to the **Display Properties** window. Automatic re-booting may commence at this moment.

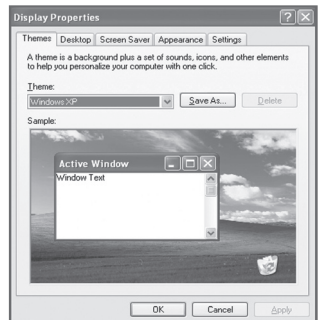

Input Mode (PC)

Both screen position and size will vary depending on the type of PC monitor and its resolution. The table below shows all of the display modes that are supported:

D-Sub Input

Mode	Resolution	Horizontal Frequency (kHz)	Vertical Frequency (Hz)	Pixel Clock Frequency (MHz)	Sync Polarity (H/V)	PS42A456/ PS42A457	PS50A456/ PS50A457
IBM	640 x 350	31.469	70.086	25.175	+ / -	✓	✓
	720 x 400	31.469	70.087	28.322	- / +	✓	✓
VESA	640 x 480	31.469	59.940	25.175	- / -	✓	✓
	640 x 480	37.861	72.809	31.500	- / -	✓	✓
	640 x 480	37.500	75.000	31.500	- / -	✓	✓
	800 x 600	37.879	60.317	40.000	+ / +	✓	✓
	800 x 600	48.077	72.188	50.000	+ / +	✓	✓
	800 x 600	46.875	75.000	49.500	+ / +	✓	✓
	1024 x 768	48.363	60.004	65.000	- / -	✓	✓
	1024 x 768	56.476	70.069	75.000	- / -	✓	✓
	1024 x 768	60.023	75.029	78.750	+ / +	✓	✓
	1360 x 768	47.712	60.015	85.500	+ / +	✓	✓

HDMI/DVI Input

Mode	Resolution	Horizontal Frequency (kHz)	Vertical Frequency (Hz)	Pixel Clock Frequency (MHz)	Sync Polarity (H/V)	PS42A456/ PS42A457	PS50A456/ PS50A457
VESA	640 x 480	31.469	59.940	25.175	- / -	✓	✓
	800 x 600	37.879	60.317	40.000	+ / +	✓	✓
	1024 x 768	48.363	60.004	65.000	- / -	✓	✓
	1360 x 768	47.712	60.015	85.500	+ / +	✓	✓

- ◆ When using an HDMI/DVI cable connection, you must use the HDMI IN 2 jack.
- ◆ The interlace mode is not supported.
- ◆ The set might operate abnormally if a non-standard video format is selected.
- ◆ Separate and Composite modes are supported. SOG is not supported.
- ◆ For the PS42A456, PS42A457, PC text quality is optimum in **VESA** mode(1024 x 768@60Hz).
- ◆ For the PS50A456, PS50A457, PC text quality is optimum in **VESA** mode (1360 x 768@60Hz).

Setting the PC

➤ Preset to the **PC** mode by pressing the **SOURCE** button.

- 1 Press the **MENU** button to display the menu.
- 2 Press the **▲** or **▼** button to select **Picture**, then press the **ENTER** button.
- 3 Select the required option by pressing the **▲** or **▼** button, then press the **ENTER** button.
- 4 When you are satisfied with your setting, press the **ENTER** button.
- 5 Press the **EXIT** button to exit.

◆ Auto Adjustment :

Auto adjustment allows the PC screen of set to self-adjust to the incoming PC video signal. The values of fine, coarse and position are adjusted automatically.

Easy Setting

- 1 Press the **TOOLS** button on the remote control.
- 2 Press the **▲** or **▼** button to select **Auto Adjustment**, then press the **ENTER** button.

◆ Screen Adjustment: Coarse/Fine/Position/Image Reset

Coarse/Fine

The purpose of picture quality adjustment is to remove or reduce picture noise.

If the noise is not removed by Fine-tuning alone, then adjust the frequency as best as possible (coarse) and Fine-tune again.

After the noise has been reduced, re-adjust the picture so that it is aligned on the center of screen.

- 1 Press the **▲** or **▼** button to select **Coarse** or **Fine**, then press the **ENTER** button.
- 2 Press the **◀** or **▶** button to adjust the screen quality, vertical stripes may appear or the picture may be blurry. Press the **ENTER** button.

Position

Adjust the PC's screen positioning if it does not fit the TV screen.

- 1 Adjust the position by pressing the **▲/▼/◀/▶** button.
- 2 Press the **ENTER** button.

Image Reset

You can replace all image settings with the factory default values.

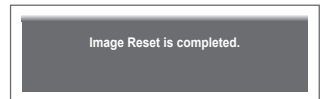
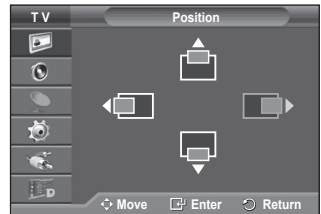
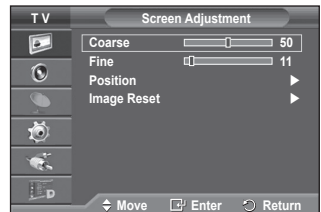
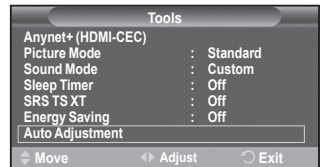
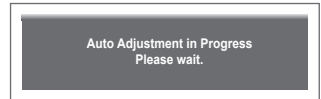
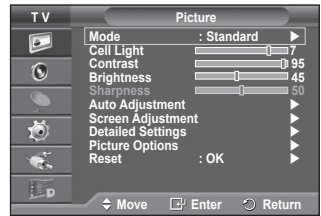

Previewing the DTV Menu System

- ◆ The company does not guarantee the normal operation of the DTV menu for countries other than the 8 supported countries (United Kingdom, France, Germany, Italy, Netherlands, Spain, Switzerland, Austria) because only these country standards are supported. In addition, when the country of the broadcast stream differs from the country selected by the current user, the string appearing in the channel banner, Info, Guide, Channel List, etc. may not be displayed properly.
- ◆ Available in DTV mode. Preset to the DTV mode by using the **TV/DTV** button on your remote control. To help you navigate around the on-screen menu system and adjust the various settings available, refer to the following illustration.

Press the **MENU** button to display the menu.

Press the **▲** or **▼** button to select **Digital Menu**, then press the **ENTER** button.

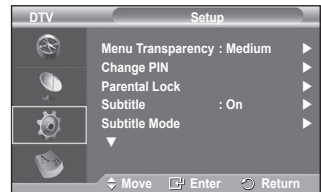
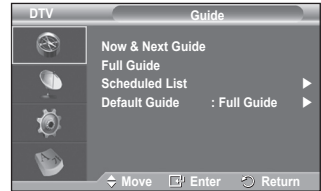
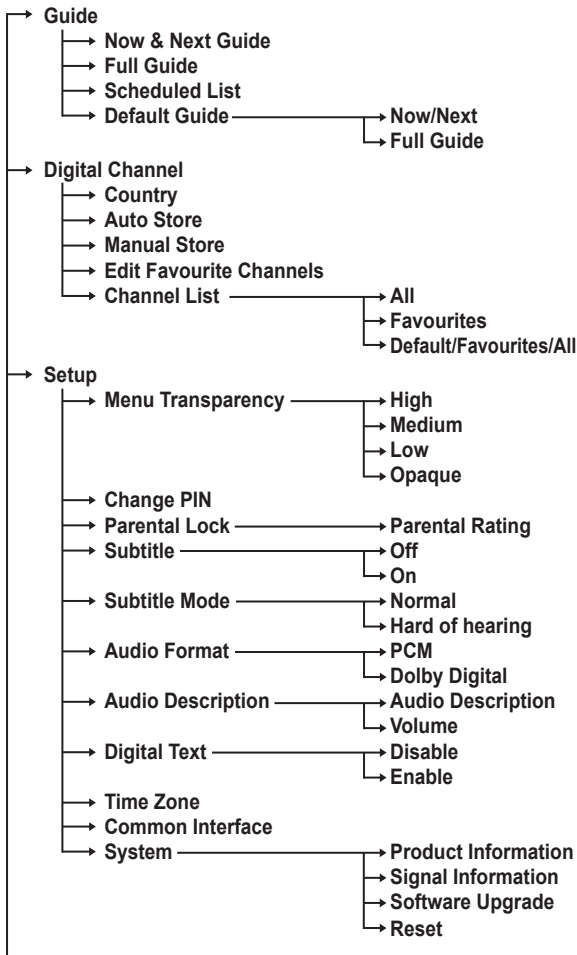

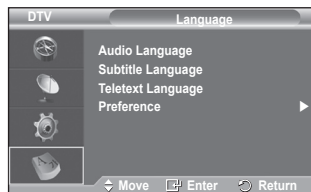
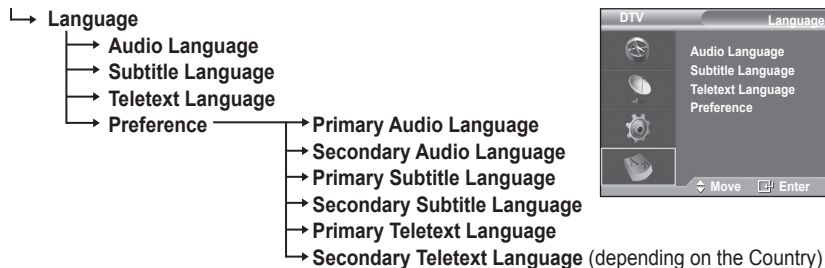

➤ The sub-items of the CI Menu may vary depending on the CAM model. (refer to page 40)

Displaying Programme Information

While viewing a channel, additional information about the current programme may be displayed.

- ◆ While viewing a programme, press the **INFO** button. The programme information is displayed.
 - The information is displayed:
 - Parental Rating
 - Video Type: SD, HD, Radio
 - Audio Type: Mono, Stereo, Dual, Dolby Digital
 - Existence of Teletext or DVB Subtitle
 - Audio Language
 - To exit from banner information, press the **INFO** button.



Operating the DTV Menu

Viewing the DTV Menu

After installing your antenna system and TV with appropriate connectors.

- ◆ Plug in the AC main power and switch on the TV.
- ◆ Press the **MENU** button to display the menu.
Press the **▲** or **▼** button to select **Digital Menu**, then press the **ENTER** button.
The main menu appears on the screen. Its left side has four icons: **Guide**, **Digital Channel**, **Setup**, and **Language**.

1. Digital Channel

This menu consists of 5 sub-menus:

Country, **Auto Store**, **Manual Store**, **Edit Favourite Channels**, and **Channel List**.

- ◆ Press the **▲** or **▼** button to select **Channel**, then press the **ENTER** button. The Channel menu is displayed.

1.1 Country

- ◆ Press the **ENTER** button. The **Country** menu is displayed. Select your country by pressing the **▲** or **▼** button, then press the **ENTER** button.
- Even though you have changed the country setting in this menu, the country setting for Analog TV is not changed. (Refer to page 10)

1.2 Auto Store

You can update the channel list when the broadcaster adds new services or if you move the TV to a new location.

- ◆ Press the **ENTER** button to select **Auto Store**. Press the **ENTER** button again to start the search. When it has finished, the number of scanned services will be displayed.
 - The existing favourite channel list will not be deleted when the channel list is updated.
 - To stop the scan before it has finished, press the **ENTER** button with **Stop** selected.
- If the signal status is poor, **No service found! Check the aerial connection.** message is displayed.

1.3 Manual Store

You can specify the channel for a fast channel search.

- ◆ - **Channel**
Press the **▲**, **▼** or numeric buttons (0~9) to select a channel.
The available channels are 21~68. The corresponding frequency for the selected channel is automatically set.
- **Frequency**
If you do not know the exact frequency, follow the above step to select the frequency automatically using channel.
- **Bandwidth**
The available bandwidths are 7 and 8 MHz.

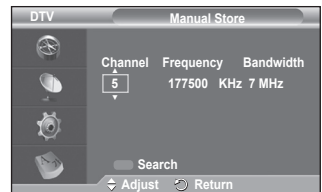
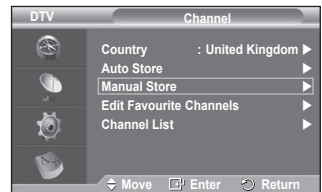
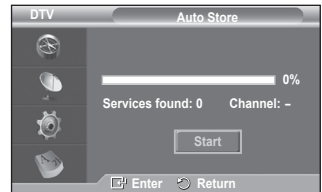
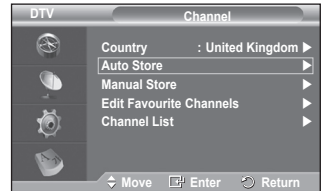

Continued...

- ◆ Press the red button to start the scan for digital services. When it has finished, channels are updated in the channel list.
- You can input by pressing the button on the remote control.
- You can not change only frequency and when changing a channel the Frequency will be automatically changed.

1.4 Edit Favourite Channels

You can edit your favourite channels using the colour buttons.

- In the case of DTV mode, **OK** or **Select** can be used as the **ENTER** button.
- ◆ Press the red button in the Edit Favourite Channels menu to display all currently stored channels.
- ◆ Press the **▲** or **▼** button to select a channel you want. Press the **ENTER** button. A "★" icon is shown next to the selected channel and the channel will be added to the favourites list.
 - ◆ To undo, press the **ENTER** button again.
 - ◆ **Select All:** Select all channels currently displayed.
 - ◆ **Select None:** Deselect all selected channels.
 - ◆ **Preview:** Displays (a) currently selected channel(s).
- If The Favourite Channels settings have been completed.

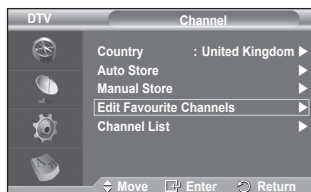

- ◆ **Add**
You can use this function when one or more favourite channels have been selected.
 - Press the red button in the **Edit Favourite Channels** menu. To add more channels, refer to the previous section.
 - To add all channels to the favourites channel list, press the red button.
 - To remove all channels, press the green button.
 - **Preview:** Displays (a) currently selected channel(s).
 - Press the **CH LIST** button to display the favourite channel list.

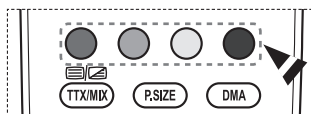

- ◆ **Renumber** (depending on the Country)
 - In the Edit Favourite Channels menu, press the **▲** or **▼** button to select the required channel.
 - Press the green button.
 - The space for entering the number is a blank.
 - Enter the new channel number. Press **ENTER** button to store or **RETURN** button to cancel.
 - Press the **◀** button to delete an entered digit.
 - If you enter a number already assigned to another channel, the number is assigned to the selected channel and the previous number assigned to the selected channel is assigned to the other channel. That is, the two numbers are exchanged.
 - The favorite channels are automatically sorted in ascending order of channel numbers.
- ◆ **Preview**
 - In the **Edit Favourite Channels** menu, press the **▲** or **▼** button to select the channel to be previewed.
 - Press the yellow button. Displays currently selected channel.
- ◆ **Delete**
 - In the **Edit Favourite Channels** menu, press the **▲** or **▼** button to select the channel to be deleted from the favourite channels list.
 - Press the blue button. The selected channel and number will be deleted.
 - To add a deleted channel back in to the favourite channel list, see **Add**.

Continued...

1.5 Channel List

You can display a list of all channels or your favourite channels.

- ◆ Press the **▲** or **▼** button to select **Channel List**, then press the **ENTER** button.
 - It can be displayed simply by pressing the **CH LIST** button.
- ◆ Press the yellow button to toggle between your favourite channels and all channels.

Your favourite channels are only displayed if they were previously set in the **Edit Favourite Channels menu** (refer to page 33).
- ◆ Press the red or green button to display the previous or next channel list page.
- ◆ Press the **▲** or **▼** button to select a channel to be tuned, then press the **ENTER** button.
 - The channel number, name and an icon are displayed in the top left corner while changing the channel. The channel number and name are displayed if the channel is one of the all channels, and a **★** icon if the channel is one of the favourite channels.
- ◆ Press the blue or **CH LIST** button to exit from the channel list.

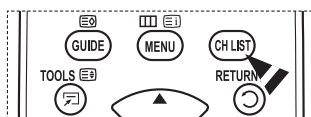

2. Guide

This menu consists of 4 sub-menus:

Now & Next Guide, Full Guide, Scheduled List, and Default Guide.

2.1 Now & Next Guide / Full Guide

The EPG (Electronic Programme Guide) information is provided by the broadcasters. Programme entries may appear blank or out of date as a result of the information broadcast on a given channel.

The display will dynamically update as soon as new information becomes available.

- **Now & Next Guide**

For the six channels indicated in the left-hand column, displays the Current programme and the Next programme information.
- **Full Guide**

Displays the programme information as time ordered 1 hour segments. 2 hours of programme information is displayed which may be scrolled forwards or backwards in time.
- ◆ Press the **▲** or **▼** button to select **Now & Next Guide** or **Full Guide**. Press the **ENTER** button. The selected guide menu is displayed.
 - Press the red button to toggle between **Now & Next Guide** or **Full Guide**.
 - Press the green button to display **Favourites** or **All Channels** list.
 - Press the yellow button to scrolls backwards quickly (24 hours).
 - Press the blue button to scrolls forwards quickly (24 hours).
 - You can also display the guide menu simply by pressing the **GUIDE** button.
- ◆ To watch a programme in the EPG list, press the **▲/▼/◀/▶** button to select a programme of your choice, then press the **ENTER** button.
 - If the next programme is selected, it is scheduled with the clock icon displayed. If the **ENTER** button is pressed again, the scheduling is canceled with the clock icon gone. For details about scheduling programmes, refer to the section.

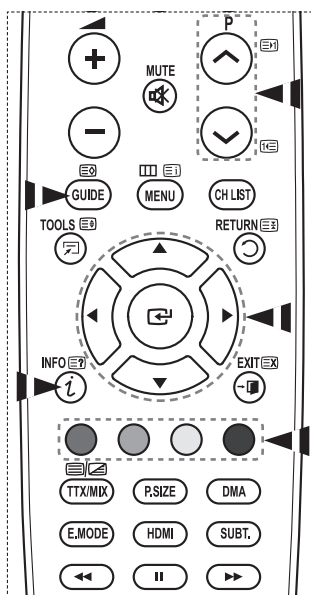

Continued...

- ◆ To view programme information, press the ▲/▼/◀/▶ button to select a programme of your choice, then press the **INFO** button.
 - ◆ Information such as the channel number, programme title and running time, status bar, and brief summary of the highlighted programme will be displayed in the top right corner of the screen. If there is a lengthy summary, “...” will be displayed. Press the **INFO** button for the full summary text.
 - ◆ Six channels are displayed. To scroll between channels, move to a channel using the ▲ or ▼ button. To display page by page, use the P◀ or ▶ button.

2.2 Scheduled List

If you make a scheduled viewing list of programs you may like to see, the channel will be automatically switched to the scheduled program at the scheduled time even if you are watching another program.

- ◆ Press the red button to add a new programme. The menu for adding a programme is displayed with **Channel** selected.
- ◆ Press the ▲/▼ and **ENTER** buttons to set the required channel, time, date, and frequency. When you are satisfied with your settings, save the adjusted schedule by pressing the red button.
- ◆ If you want to edit the scheduled programme, select a programme by pressing the ▲ or ▼ button, then press the green button. If necessary, select the programme to be deleted by pressing the ▲ or ▼ button, then press the blue button.
 - When watching analog TV, the reserved DTV channel cannot be changed. The channel is only changed automatically to the reserved channel when you are watching DTV.
 - Scheduling programme only functions with the television already turned on, and not from standby mode. For details about switching the television on and off automatically, refer to page 9.

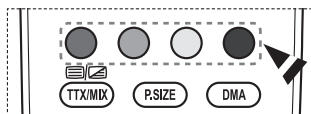
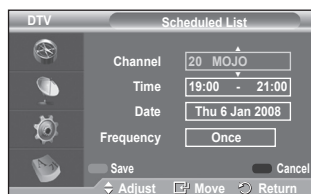

2.3 Default Guide

You can preset the default guide style.

- ◆ Press the ▲ or ▼ button to select the required option (**Now/Next** or **Full Guide**), then press the **ENTER** button. The selected option for default guide is displayed on the EPG menu and the channel list appears.

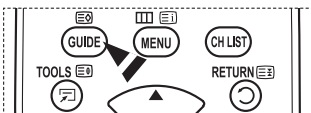
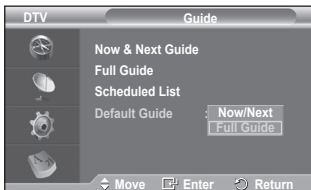
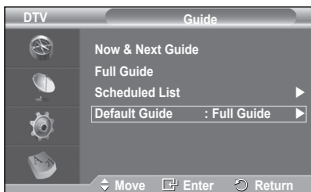

Continued...

2.4 All Channels and Favorite Channels

In the EPG menu, you can display all channels or favourite channels.

- ◆ Press the green button repeatedly to toggle between the all and favourite channels list.

When the favorite channel list has not been set up:

- **The favorite list is empty. Would you like to choose your favorite now?** message is displayed.
- Select **Yes**. The **Edit Favourite Channels** menu is displayed. If you select **No**, all channels will remain unchanged.
- To edit the favourite channels, refer to page 33 for more details.

- ◆ **All Channels** is the list of channels that have been scanned by the channel list update. All channels are displayed in the all channel mode.
- ◆ **Favourites** (favourite channels) is the list of channels that has been set in the **Edit Favourite Channels** menu (refer to page 33).
- ◆ When there is no channel information, the **No Data** message will be displayed and you will not be able to change the channel even if you press the **ENTER** button.

When the **No Data** message appears and you cannot change the channel, press the channel number directly using the numeric buttons.

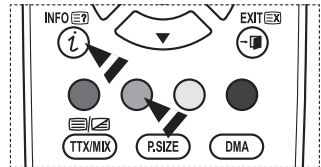
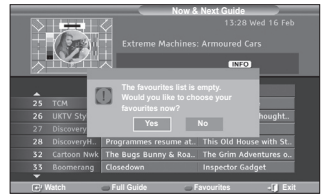
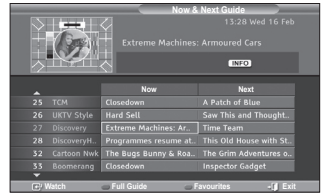
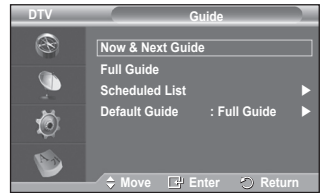

3. Language

This menu consists of 4 sub-menus:

Audio Language, Subtitle Language, Teletext Language, and Preference.

3.1 Audio Language / Subtitle Language / Teletext Language

You can change the default value for subtitle, audio and teletext languages.

- ◆ Press the **▲** or **▼** button to select required menu (**Audio Language, Subtitle Language, or Teletext Language**), then press the **ENTER** button. The options of the selected menu are displayed.



Continued...

3.2 Preference

This menu consists of 6 sub-menus:

Primary Audio Language, Secondary Audio Language, Primary Subtitle Language, Secondary Subtitle Language, Primary Teletext Language, and Secondary Teletext Language (depending on the Country).

Using this feature, users can select one of the languages (English, German, Italian, Swedish, French, Welsh, Gaelic, Irish, Danish, Finnish, Spanish, Dutch). The language selected here is the default when the user selects a channel.

- ◆ Press the ▲ or ▼ button to select required menu (**Primary Audio Language, Secondary Audio Language, Primary Subtitle Language, Secondary Subtitle Language, Primary Teletext Language, or Secondary Teletext Language**), then press the ENTER button.

The options of the selected menu are displayed.

- ◆ Press the ▲ or ▼ button to select required option (**English, German, Italian, Swedish, French, Welsh, Gaelic, Irish, Danish, Finnish, Spanish, Dutch**), then press the ENTER button.

- ◆ If you change the language setting, the **Audio Language, Subtitle Language, and the Teletext Language** of the **Language** menu (refer to page 36) are automatically changed to the selected language.

- ◆ The **Audio Language, Subtitle Language, and the Teletext Language** of the **Language** menu show a

list of languages supported by the current channel and the selection is highlighted. If you change this language setting, the new selection is only valid for the current channel. The changed setting does not change the setting of the **Primary Audio Language, Primary Subtitle Language, or the Primary Teletext Language** of the **Preference** menu.

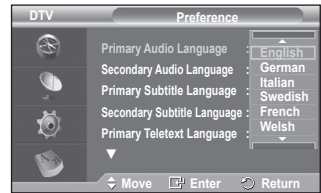
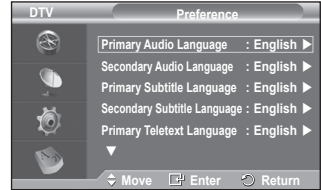

Continued...

4. Setup

This menu consists of 11 sub-menus:

Menu Transparency, Change PIN, Parental Lock, Subtitle, Subtitle Mode, Audio Format, Audio Description, Digital Text, Time Zone, Common Interface and System.

4.1 Menu Transparency

You can set the translucency of the on-screen menu.

- ◆ Press the ▲ or ▼ button to select required option (**High, Medium, Low, or Opaque**), then press the ENTER button.

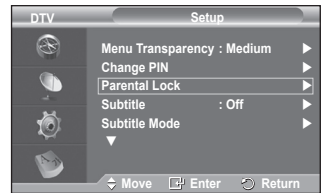
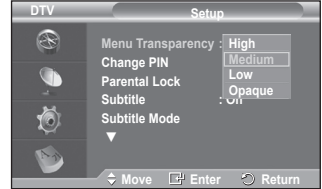
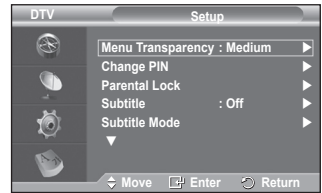

4.2 Change PIN / Parental Lock

This feature allows you to prevent unauthorized users, such as children, from watching unsuitable programmes by a 4-digit PIN (Personal Identification Number) code that is defined by the user.

The on-screen menu will instruct you to assign a PIN code (you can change it later, if necessary).

- ◆ Enter your current 4-digit PIN code by using the numeric buttons (0~9). The **Parental Lock** menu are displayed with the **Parental Rating** selected.
 - ◆ The default PIN code for a new TV set is **0000**.
 - ◆ If you enter an invalid PIN code, the **Invalid PIN code. Please try again.** message is displayed.
- ◆ Press the ENTER button. Press the ▲ or ▼ button to select the age rating you want to lock out, then press the ENTER button.
- ◆ If you want to change the PIN code, press the ▲ or ▼ button to select **Change PIN**, then press the ENTER button.
 - Enter your new PIN code by using the numeric buttons (0~9). The **Confirm New PIN** is displayed.
 - Re-enter your new PIN code to confirm by using the numeric buttons (0~9). The **Your PIN code has been changed successfully.** message is displayed.
- If you forget the PIN code, press the remote control buttons in the following sequence, which resets the PIN to **0-0-0-0: POWER (Off) → MUTE → 8 → 2 → 4 → POWER (On)**.

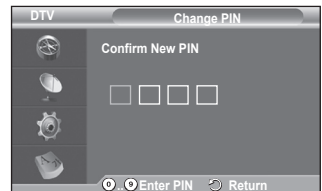
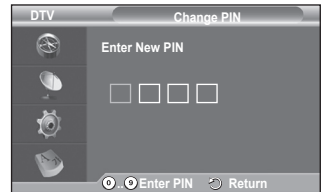
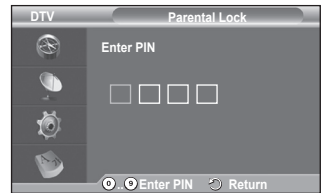

Continued...

4.3 Subtitle / Subtitle Mode / Audio Format / Audio Description / Digital Text

You can use various settings to suit your personal preferences.

- ◆ Press the ▲ or ▼ button to select required menu (**Subtitle**, **Subtitle Mode**, **Audio Format**, **Audio Description** or **Digital Text**), then press the **ENTER** button. The options of the selected menu are displayed.
- ◆ Press the ▲ or ▼ button to select required option, then press the **ENTER** button.
- **Subtitle : On / Off**
 - You can select these options simply by pressing the **SUBTITLE** button on the remote control.
- **Subtitle Mode : Normal (basic subtitle) / Hard of hearing** (subtitle for a hearing-impaired person)
 - If the programme you are watching does not support the **Hard of hearing** function, **Normal** automatically activates even though **Hard of hearing** mode is selected.

- Audio Format

You can only hear Dolby Digital sound through the audio receiver connected through an optical cable. You can only hear PCM sound through the main speaker.

When sound is emitted from both the main speaker and the audio receiver, a sound echo may occur due to the decoding speed difference between the main speaker and the audio receiver. In this case, use the internal mute function.

- Even if you have selected PCM or Dolby Digital in Audio Format, when the input signals are any format of PCM and Dolby Digital, the input format is applied regardless of the setting. If the input signals are not any of those, the setting is not applied.

- Audio Description

This is an auxiliary audio function that provides an additional audio track for visually challenged persons. This function handles the Audio Stream for the **AD (Audio Description)**, when it is sent along with the **Main audio** from the broadcaster. Users can turn the **Audio Description On** or **Off** and control the volume.

- Digital Text : Enable / Disable (UK only)

- If the programme is broadcast with digital text, this feature is enabled.
- **MHEG** (Multimedia and Hypermedia Information Coding Experts Group)?
An International standard for data encoding systems used in multimedia and hypermedia. This is at a higher level than the MPEG system which includes data-linking hypermedia such as still images, character service, animation, graphic and video files as well as multimedia data. MHEG is user runtime interaction technology and is being applied to various fields including VOD (Video-On-Demand), ITV (Interactive TV), EC (Electronic Commerce), tele-education, tele-conferencing, digital libraries and network games.

4.4 Time Zone (Spain only)

You can select the time zone where you are located.

- This menu is only enabled when you select a country supported by the time zone.

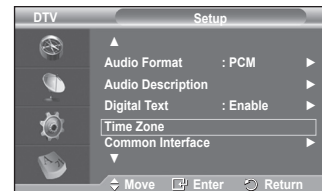
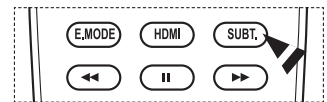
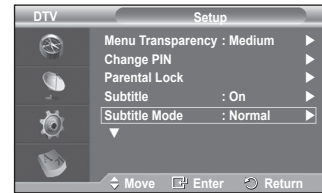
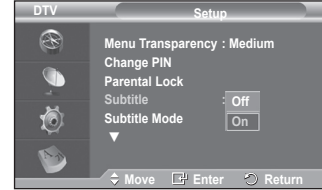
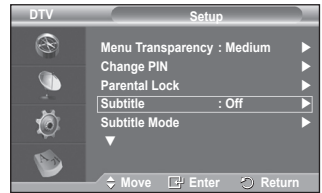

Continued...

4.5 Common Interface

- Installing the CI Card

- ◆ Purchase the CI CAM module by visiting your nearest dealer or by phone.
- ◆ Insert the CI CARD into the CAM in the direction of the arrow until it fits.
- ◆ Insert the CAM with the CI CARD installed into the common interface slot.
 - Insert the CAM in the direction of the arrow, right up to the end so that it is parallel with the slot.
- ◆ Check if you can see a picture on a scrambled signal channel.
 - You can install the CAM anytime whether the TV is ON or OFF.

- Application Info.

This contains information on CAM inserted in the CI slot and displays it.

- ◆ Press the **ENTER** button to display the information for your application.

- CI Menu

This helps the user select an item from the CAM-supported menu.

- ◆ Press the **ENTER** button. The options of the selected menu are displayed. Press the **▲** or **▼** button to select the required option, then press the **ENTER** button.
 - Select the CI Menu based on the PC Card menu.

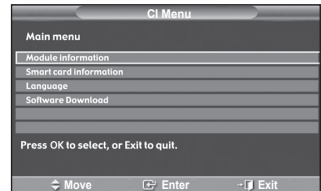
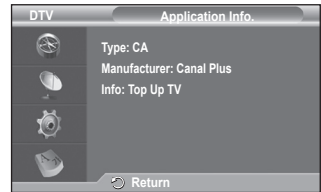

4.6 System

This menu consists of 5 sub-menus:

Product Information, Signal Information, Software Upgrade, and Reset.

- Product Information

You can view your product information. For service or repair, please contact a Samsung approved dealer.

- ◆ Press the **ENTER** button with **Product Information** selected. The product information menu is displayed.
 - **Software Version / Firmware Version**

- Signal Information

You can get information about the signal status.

- ◆ Press the **ENTER** button with **Signal Information** selected. The technical information for signal status is displayed.
 - **Service / Service ID / Multiplex / Network / Bit error level / Signal Strength**

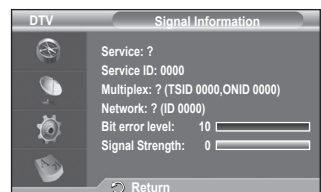
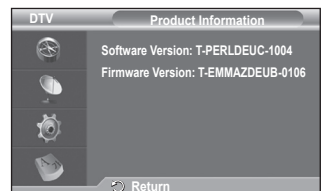
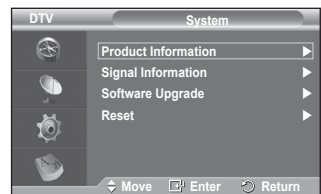
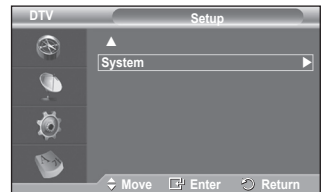

Continued...

- Software Upgrade (Option)

To keep your product up-to-date with new digital television features then software upgrades are periodically broadcast as part of the normal television signal. It will automatically detect these signals and display the software upgrade banner. You are given the option to install the upgrade.

◆ Software Information

Press the **ENTER** button, then the current software version is shown. To display the software version information, press the **ENTER** button again.

◆ Manual Upgrade

Press the **ENTER** button to search for new software from the currently broadcasting channels.

◆ Standby Mode Upgrade : On / Off

Press the **ENTER** button. To continue software upgrade with master power on, Select **On** by pressing the **▲** or **▼** button.

45 minutes after entering standby mode, a manual upgrade is automatically conducted. Since the power of the unit is turned on internally, the screen may be on slightly for the PDP product. This phenomenon may continue for more than 1 hour until the software upgrade is completed.

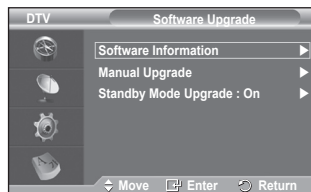

- Reset

You can reset the values stored to the factory default values.

➤ The Reset operation deletes all channel information and user preferences returning all values to their default factory state.

◆ Press the **ENTER** button with **Reset** selected.

The **Enter PIN** is displayed.

◆ Enter your current 4-digit PIN code by using the numeric buttons (0~9). The warning message is displayed. All values will be reset by pressing the coloured buttons (red, green, yellow, and blue) in turn.

➤ The default PIN of a new TV set is "0-0-0-0".

➤ When PIN is changed in Child Lock, the PIN for resetting automatically changes.

◆ When reset is complete, it operates DTV Plug & Play (DTV Auto Store, Time Zone-depending on the country, Time Setting) and exits from the digital TV mode without changing to the analog TV mode. (Refer to page 10)

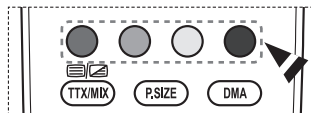

What is Anynet+?

Anynet+ is an AV network system that enables an easy-to-use AV interface for users by controlling all connected AV devices through the Anynet+ menu when Samsung Electronics AV devices are connected.

Connecting Anynet+ Devices

The Anynet+ system supports AV devices supporting Anynet+ only. Check if there is an Anynet+ mark on the AV device to be connected to the TV.

To directly connect to TV

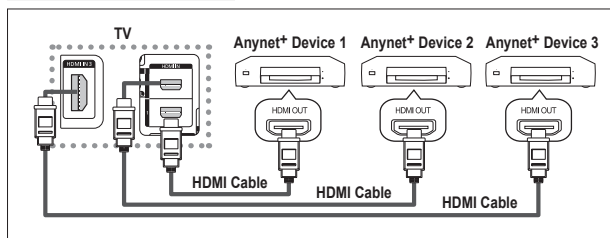

Connect the [HDMI 1], [HDMI 2] or [HDMI 3] jack on the TV and the HDMI OUT jack of the corresponding Anynet+ device using the HDMI cable.

To connect to Home Theatre

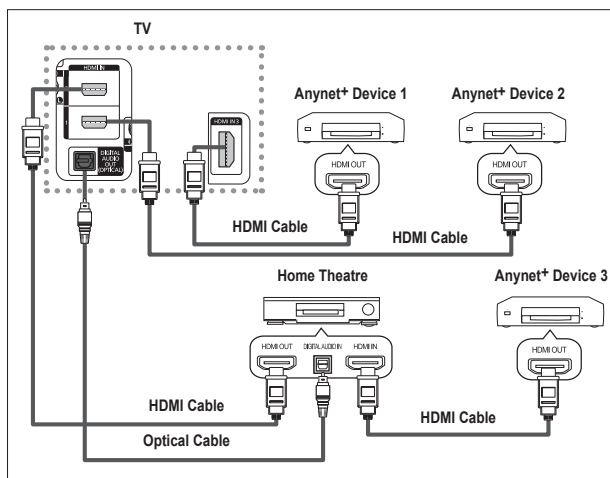

- 1 Connect the [HDMI 1], [HDMI 2] or [HDMI 3] jack on the TV and the HDMI OUT jack of the corresponding Anynet+ device using the HDMI cable.
- 2 Connect the HDMI IN jack of the home theatre and the HDMI OUT jack of the corresponding Anynet+ device using the HDMI cable.

- Connect only the optical cable between [Digital Audio Out (Optical)] on your TV and Digital Audio Input on the receiver.
- Connect only one receiver.
- You can listen to 5.1 channel sound through the home theatre's speakers. Otherwise, you can only listen to 2 channel stereo sound in other cases. Make sure to connect the Digital Audio IN (Optical) of the home theatre and the TV correctly to listen to TV sound through the home theatre. However, you cannot listen to sound from the BD recorder that is sent to the home theatre via the TV in 5.1 channel sound because the TV outputs only 2 channel stereo sound. Please see the manual for the home theatre.
- You can connect an Anynet+ device using the HDMI cable. Some HDMI cables may not support Anynet+ functions.
- Anynet+ works when the AV device supporting Anynet+ is in the Standby or On status.
- Anynet+ supports up to 8 AV devices in total.

Setting Up Anynet+

The following settings are to use Anynet+ functions.

Using the Anynet+ Function

- 1 Press the **MENU** button to display the menu. Press the **▲** or **▼** button to select **Input**, then press the **ENTER** button.
 - 2 Press the **▲** or **▼** button to select **Anynet+ (HDMI-CEC)**, then press the **ENTER** button.
 - 3 Press the **▲** or **▼** button to select **Setup**, then press the **ENTER** button.
 - 4 Press the **▲** or **▼** button to select **Anynet+ (HDMI-CEC)**, then press the **ENTER** button.
 - 5 Press the **▲** or **▼** button to select **On**, then press the **ENTER** button.
- The Anynet+ (HDMI-CEC) function is enabled.
 - If you select **Off**, Anynet+ (HDMI-CEC) is disabled.
 - When the Anynet+ (HDMI-CEC) function is disabled, all the Anynet+ related operations are deactivated.

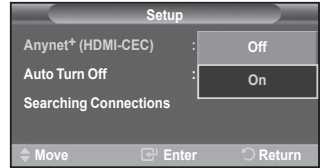

Turning an Anynet+ Device Off Automatically when the TV is Turned Off

- 4 Press the **▲** or **▼** button to select **Auto Turn Off**, then press the **ENTER** button.
 - 5 Press the **▲** or **▼** button to select **Yes**, then press the **ENTER** button.
- The Auto Turn Off function is enabled.
 - If you select **No**, the Auto Turn Off function is canceled. Press the **EXIT** button to exit.
 - The Select Device setting of the TV remote control is to be set to TV to use the Anynet+ function.
 - If you set **Auto Turn Off** to **Yes**, connected external devices are also turned off when the TV is turned off. However, if the device is recording, it may not be turned off.

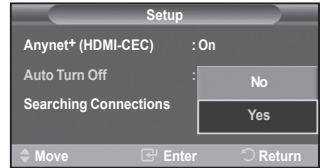

Scanning and Switching between Anynet+ Devices

- 1 Press the **MENU** button to display the menu. Press the **▲** or **▼** button to select **Input**, then press the **ENTER** button.
- 2 Press the **▲** or **▼** button to select **Anynet+ (HDMI-CEC)**, then press the **ENTER** button.
- 3 Press the **▲** or **▼** button to select **Select Device**, then press the **ENTER** button.
- 4 Press the **▲** or **▼** button to select to a particular device and press the **ENTER** button. It is switched to the selected device.
- 5 If you cannot find a device you want, press the **▲** or **▼** button to select **Searching Connections**, then press the **ENTER** button.

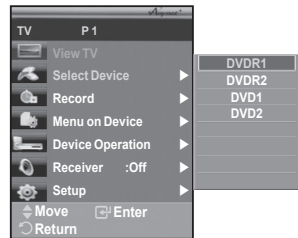

The message **Configuring Anynet+ connection...** is displayed. When searching devices completes, the connected devices are listed in the Anynet+ menu.

- Switching to the selected devices may take up to 2 minutes. You cannot cancel the operation during the switching operation.
- The time required to scan for devices is determined by the number of connected devices.
- When the device scan is complete, the number of found devices is not displayed.
- Although the TV automatically scans devices when it is turned on using the **POWER** button, devices connected when the TV is on or under a specific circumstance are not displayed in the device list. Therefore select **Searching Connections** menu to search devices.
- If you have selected external input mode by pressing the **SOURCE** button, you cannot use the Anynet+ function. Make sure to switch to an Anynet+ device by using the **TOOLS** button.

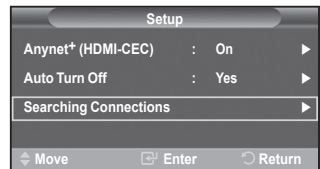

Anynet+ Menu

The Anynet+ menu changes depending on the type and status of the Anynet+ devices connected to the TV.

Anynet+ Menu	Description
View TV	Switches from Anynet+ to TV broadcast mode.
Select Device	Your TV connects to the corresponding device.
Record	Starts a recording. (This menu works only for a device supporting recording.)
Menu on Device	Shows the menu of the connected device. Example. When a DVD Recorder is connected, the DVD Recorder's title menu appears.
Device Operation	Shows the play control menu of the connected device. Example. When a DVD Recorder is connected, the play control menu of the DVD Recorder appears.
Receiver	Sound is output through the receiver.
Setup	You can set the environment for using Anynet+.

TV Remote Control Buttons Available in Anynet+ Mode

Device Type	Operating Status	Available Buttons
Anynet+ Device	After switching to the device, when the menu of the corresponding device is displayed on the screen.	Numeric buttons ▲/▼/◀/▶/ENTER buttons Colour buttons EXIT button
	After switching to the device, while playing a file	⏮ (Backward search) ⏭ (Forward search) ⏹ (Stop) ⏸ (Play/Pause)
Device with built-in Tuner	After switching to the device, when you are watching a TV programme	P ⏻/⏺ button
Audio Device	When a Receiver is activated	▲ + / - button MUTE button

- The Anynet+ function only works when the remote control is set to TV.
- The **REC** button works only while in the recordable state.
- You cannot control Anynet+ devices using the buttons on the side of the TV. You can control Anynet+ devices only using the TV remote control.
- The TV remote control may not work under certain conditions. In this case, reselect the Anynet+ device.
- The Anynet+ functions don't operate for the products from other manufacturers.
- In Anynet+ mode, the colour buttons may not work properly.
- The ⏮, ⏭ operations may differ depending on the device.

Recording

You can make a recording of a TV programme using a recorder.

Press the **REC** button.

Recording begins. (Only when the Anynet+ enabled recording device is connected.)

- The current TV programme is recorded in the Watching TV status. If you are watching video from another device, the video from the device is recorded.
- You can also record the source streams by selecting **Record** after pressing the **TOOLS** button.
- Before recording, check whether the antenna jack is properly connected to the recording device. For the antenna connection to the recording device, refer to its user manual.

Listening through a Receiver

You can listen to sound through a receiver instead of the TV speaker.

- 1 Press the **MENU** button to display the menu.
Press the **▲** or **▼** button to select **Input**, then press the **ENTER** button.
- 2 Press the **▲** or **▼** button to select **Anynet+ (HDMI-CEC)**, then press the **ENTER** button.
- 3 Press the **▲** or **▼** button to select **Receiver**, then press the **ENTER** button.
- 4 Press the **◀** or **▶** button to select to **On**, then press the **ENTER** button.
Now you can listen to sound through the receiver.
- 5 Press the **EXIT** button to exit.
 - When the receiver is set to On, you can listen to the TV sound through the 2-channel receiver.
 - If the receiver is exclusively for a home theater only (supporting audio only), it may not appear in the device list.
 - Only when you have connected the optical jack of the TV and the receiver properly, does Receiver work.
 - In case of a content with copyright problems, listening through the receiver may not properly operate.



Check Points before Requesting Service

Symptom	Solution
Anynet+ does not work.	<ul style="list-style-type: none"> ■ Check if the device is an Anynet+ device. The Anynet+ system supports Anynet+ devices only. ■ Connect only one receiver. ■ Check if the Anynet+ device power cord is properly connected. ■ Check the Anynet+ device's Video/Audio/HDMI cable connections. ■ Check whether Anynet+ (HDMI-CEC) is set to On in the Anynet+ setup menu. ■ Check whether the TV remote control is in TV mode. ■ Check whether it is Anynet+ exclusive remote control. ■ Anynet+ doesn't work at a certain condition. (Searching channels) ■ When connecting or removing the HDMI cable, please make sure to search devices again or restart your TV. ■ Check if the Anynet+ Function of Anynet+ device is set on.
I want to start Anynet+.	<ul style="list-style-type: none"> ■ Check if the Anynet+ device is properly connected to the TV and check if the Anynet+ (HDMI-CEC) is set to On in the Anynet+ Setup menu. ■ Press the TV button on the TV remote control to switch to TV. Then press the TOOLS button to show the Anynet+ menu and select a menu you want.
I want to exit Anynet+.	<ul style="list-style-type: none"> ■ Select View TV in Anynet+ menu. ■ Press the SOURCE button on the TV remote control and select a device other than Anynet+ devices. ■ Press any of P, CH LIST, and PRE-CH to change to the TV mode. (Note that the channel button operates only when a tuner-embedded Anynet+ device is not connected.)
The message Connecting to Anynet+ device... appears on the screen.	<ul style="list-style-type: none"> ■ You cannot use the remote control when you are configuring Anynet+ or switching to a view mode. ■ Use the remote control when the Anynet+ setting or switching to view mode is complete.
The Anynet+ device does not play.	<ul style="list-style-type: none"> ■ You cannot use the play function when Plug & Play is in progress.
The connected device is not displayed.	<ul style="list-style-type: none"> ■ Check whether or not the device supports Anynet+ functions. ■ Check whether or not the HDMI cable is properly connected. ■ Check whether Anynet+ (HDMI-CEC) is set to On in the Anynet+ setup menu. ■ Search Anynet+ devices again. ■ You can connect an Anynet+ device using the HDMI cable only. Some HDMI cables may not support Anynet+ functions.
The TV programme cannot be recorded.	<ul style="list-style-type: none"> ■ Check whether the antenna jack on the recording device is properly connected.
The TV sound is not output through the receiver.	<ul style="list-style-type: none"> ■ Connect the optical cable between TV and the receiver.

Teletext Feature (depending on the model)

Most television stations provide written information services via teletext. The index page of the teletext service gives you information on how to use the service. In addition, you can select various options to suit your requirements by using the remote control buttons.

For teletext information to be displayed correctly, channel reception must be stable. Otherwise, information may be missing or some pages may not be displayed.

- 1 TV/DTV**
Exit from the teletext display (depending on the model)
 - 2 [Store]**
Used to store the teletext pages.
 - 3 [Size]**
Press to display the double-size letters in the upper half of the screen. For lower half of the screen, press it again.
To display normal screen, press it once again.
 - 4 [Reveal]**
Used to display the hidden text (answers to quiz games, for example). To display normal screen, press it again.
 - 5 Coloured buttons (red/green/yellow/blue)**
If the FASTEXT system is used by a broadcasting company, the different topics covered on a teletext page are colour-coded and can be selected by pressing the coloured buttons. Press one of them corresponding to the required. The page is displayed with other coloured information that can be selected in the same way.
To display the previous or next page, press the corresponding coloured button.
 - 6 [Teletext on/mix]**
Press to activate teletext mode after selecting the channel providing the teletext service. Press it twice to overlap the teletext with the current broadcasting screen.
 - 7 [Mode]**
Press to select the teletext mode (LIST/FLOF).
If you press it in the LIST mode, it switches into the List save mode.
In the List save mode, you can save teletext page into list using the [Store] button.
 - 8 [Sub-page]**
Used to display the available sub-page.
 - 9 [Page up]**
Used to display the next teletext page.
 - 10 [Page down]**
Used to display the previous teletext page.
 - 11 [Index]**
Used to display the index (contents) page at any time while you are viewing teletext.
 - 12 [Hold]**
Used to hold the display on a given page if the selected page is linked with several secondary pages which follow on automatically. To resume, press it again.
 - 13 [Cancel]**
Used to display the broadcast when searching for a page.
- You can change teletext pages by pressing the numeric buttons on the remote control.

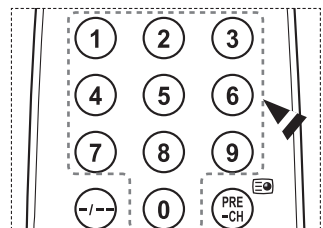
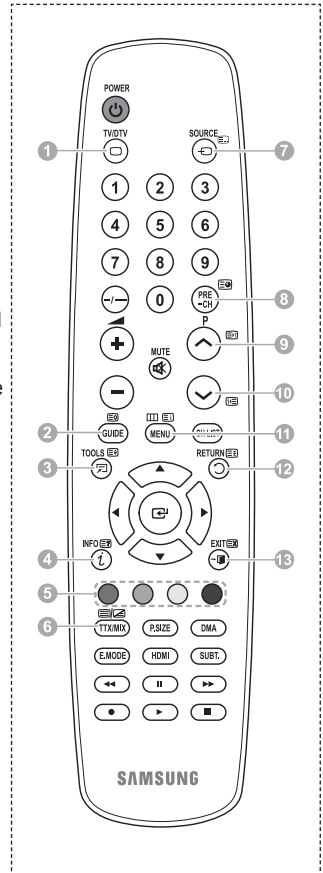

Continued...

The teletext pages are organized according to six categories:

Part	Contents
A	Selected page number.
B	Broadcasting channel identity.
C	Current page number or search indications.
D	Date and time.
E	Text.
F	Status information. FASTEXT information.

- Teletext information is often divided between several pages displayed in sequence, which can be accessed by:
 - ◆ Entering the page number
 - ◆ Selecting a title in a list
 - ◆ Selecting a coloured heading (FASTEXT system)
- Press the **TV/DTV** button to exit from the teletext display.

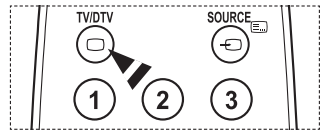
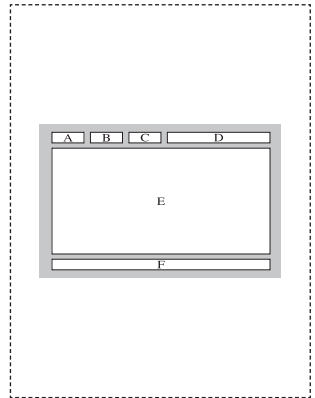

Wall Mount Kit Specifications (VESA)

Install your wall mount on a solid wall perpendicular to the floor.
 When attaching to other building materials, please contact your nearest dealer.
 If installed on a ceiling or slanted wall, it may fall and result in severe personal injury.

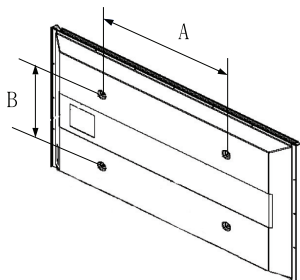

Product Family	inch	VESA Spec. (A * B)	Standard Screw	Quantity
LCD-TV	23 ~ 26	200 * 100	M4	4
	32 ~ 40	200 * 200	M6	
	46 ~ 52	400 * 400 600 * 400	M8	
	57	700 * 400 (No VESA)		
	57 ~ 70	800 * 400		
	80 ~	1400 * 800		
PDP-TV	42 ~ 58	400 * 400 600 * 400	M8	4
	63	676 * 407 (No VESA)		6
	63 ~ 70	800 * 400		4
	80 ~	1400 * 800		4

- We provided the standard dimensions for wall mount kits as shown in the table above.
- When purchasing our wall mount kit, a detailed installation manual and all parts necessary for assembly are provided.
- Do not use screws longer than the standard dimension, as they may cause damage to the inside of the TV set.
- For wall mounts that do not comply with the VESA standard screw specifications, the length of the screws may differ depending on their specifications.
- Do not use screws that do not comply with the VESA standard screw specifications.
Do not use fasten the screws too strongly, this may damage the product or cause the product to fall, leading to personal injury. Samsung is not liable for these kinds of accidents.
- Samsung is not liable for product damage or personal injury when a non-VESA or non-specified wall mount is used or the consumer fails to follow the product installation instructions.
- Our 57" and 63" models do not comply with VESA Specifications. Therefore, you should use our dedicated wall mount kit for this model.
- Do not exceed 15 degrees tilt when mounting this TV.



Do not install your Wall Mount Kit while your TV is turned on.
 It may result in personal injury due to electric shock.

Wall-mount adjustment (Sold separately)

Once the auto wall mount is installed, the position of your TV can be easily adjusted.

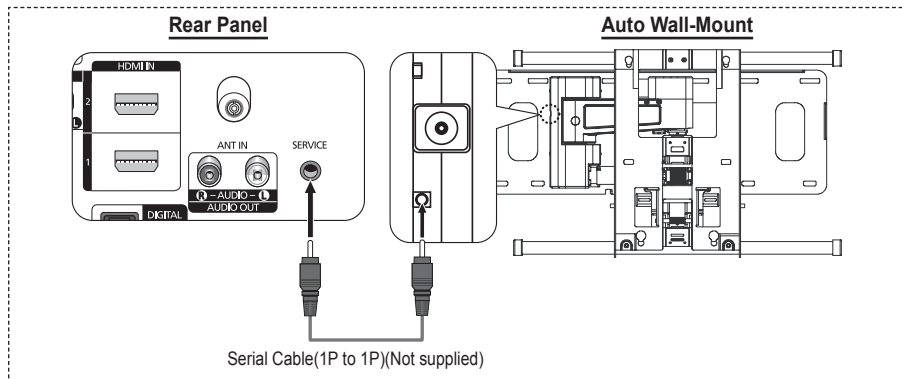

Entering the menu

- 1 Press the **▲**, **▼**, **◀** or **▶** button on your remote control.
 - The Wall Mount Adjustment screen is displayed.
 - If the Wall Mount Adjustment screen is not displayed when clicking on a direction button while watching your TV, use the menu to display that screen.
 - Press the **MENU** button to display the menu. Press the **▲** or **▼** button to select **Setup**, then press the **ENTER** button.
 - Press the **▲** or **▼** button to select **Wall-Mount Adjustment**, then press the **ENTER** button.

Remembering the Position

- 2 Adjust to the desired position using the **▲**, **▼**, **◀**, **▶** buttons.
 - If you press an arrow button when no OSD is displayed on the TV screen, the Adjustment screen appears.
 - Press the **INFO** button to reset. Press the **◀** or **▶** button to select **Yes**, then press the **ENTER** button. The position is initialized to the default setting.
- 3 Press the blue button.

Press the **▲** and **▼** buttons to select a save mode from either **Position1**, **Position2** or **Position3** in order to save the current position.

 - To not save the current position, press the **RETURN** button.
 - When selecting a save mode, you cannot use the Color buttons.
- 4 Press the **ENTER** button to save.
 - When **Position1** is selected, the message **Current position saved as Position1** is displayed.
- 5 Press the **ENTER** button.
 - The saved Position appears on the left side of the OSD.

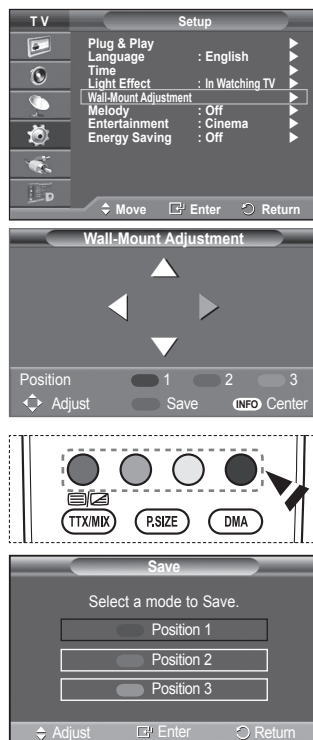

Moving to the remembered position

- 1 Complete Step 1 of **Entering the menu**.
- 2 Pressing a Color (Red, Green, Yellow) button moves the auto wall mount to the saved position.
 - You can move the wall mount to one of the 3 pre-set positions by pressing the Red (Position 1), Green (Position 2) or Yellow (Position 3) buttons.
 - If you adjust the position after moving to a pre-set position, the position display will disappear.
 - For installation, refer to the Installation Manual provided with the wall mount.
 - For product installation and the installation and moving of the wall mount, make sure to consult a specialized installation company.
 - This installation manual is to be used when attaching the wall mount to a wall. When attaching to other building materials, please contact your nearest dealer.
 - The auto wall mount will not work when Anynet+ is operating.
 - 42 inches model is not compatible with the older wall mount model (WMN5090A).

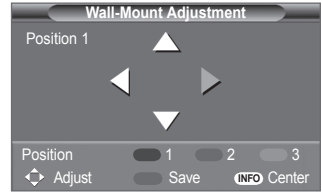

How to assemble the Stand-Base (depending on the model)

Using the 6 screws for securing the stand base and the monitor, firmly attach the monitor to the stand base.
(The exterior of the set may be different than the picture.)

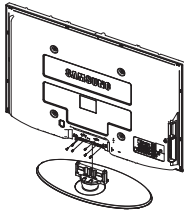

Warning

Firmly secure the stand to the TV before moving it, as the stand may fall and could cause serious injury.

- Two or more people should carry the TV. Never lay the TV on the floor because of possible damage to the screen.
Always store the TV upright.

In case of installing your TV on the wall, close the cover (1) on the stand-base connection part using two screws for hiding.

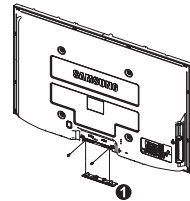

Troubleshooting

Before contacting the Samsung after-sales service, perform the following simple checks. If you cannot solve the problem using the instructions below, note the model and serial number of the television and contact your local dealer.

No sound or picture

- ◆ Check that the mains lead has been connected to a wall socket.
- ◆ Check that you have pressed the  (Power) button (On/Off) on the front panel or press the **POWER** button on the remote control.
- ◆ Check the picture contrast and brightness settings.
- ◆ Check the volume.
- ◆ Check if TV Speaker is set to Off.

Normal picture but no sound

- ◆ Check the volume.
- ◆ Check whether the volume **MUTE** button on the remote control has been pressed.

No picture or black and white picture

- ◆ Adjust the colour settings.
- ◆ Check that the broadcast system selected is correct.

Sound and picture interference

- ◆ Try to identify the electrical appliance that is affecting the television, then move it further away.
- ◆ Plug the television into a different main socket.

Blurred or snowy picture, distorted sound

- ◆ Check the direction, location and connections of your aerial.
This interference often occurs due to the use of an indoor aerial.

Remote control malfunctions

- ◆ Replace the remote control batteries.
- ◆ Clean the upper edge of the remote control (transmission window).
- ◆ Check that the "+" and "-" ends of the batteries are inserted correctly.
- ◆ Check that the batteries are drained.

Screen is black and power indicator light blinks steadily

- ◆ On your computer check; Power, Signal Cable.
- ◆ The TV is using its power management system.
- ◆ Move the computer's mouse or press any key on the keyboard.
- ◆ On your equipment check (STB, DVD, etc) ; Power, Signal Cable.
- ◆ The TV is using its power management system.
- ◆ Press the Source button on the panel or remote control.
- ◆ Turn the TV off and on.

The damaged picture appears in the corner of the screen.

- ◆ If **Just Scan** is selected in some external devices, the damaged picture may appear in the corner of the screen. This symptom is caused by external devices, not TV.

The "Resets all settings to the default values" message appears.

- ◆ This appears when you press and hold the **EXIT** button for a while. The product settings are reset to the factory defaults.

Specifications

The descriptions and characteristics in this booklet are given for information purposes only and are subject to modification without notice.

Model Name	PS42A456/PS42A457	PS50A456/PS50A457
Screen Size (Diagonal)	42 inch	50 inch
PC Resolution	1024 x 768 @ 60 Hz	1360 x 768 @ 60 Hz
Sound (Output)	10 W + 10 W	10 W + 10 W
Dimension (WxHxD) Body With stand	1055 x 725 x 94 mm 1055 x 725 x 316 mm	1231 x 756 x 95 mm 1231 x 756 x 316 mm
Weight Body With stand	27 Kg 31 Kg	35 Kg 37 Kg
Environmental Considerations Operating Temperature Operating Humidity Storage Temperature Storage Humidity	10 °C to 40 °C (50 °F to 104 °F) 10% to 80%, non-condensing -20 °C to 45 °C (-4 °F to 113 °F) 5% to 95%, non-condensing	

- ◆ This device is a Class B digital apparatus.
- ◆ Design and specifications are subject to change without prior notice.
- ◆ For the power supply and Power Consumption, refer to the label attached to the product.

Warning! Important Safety Instructions

Please read the appropriate section that corresponds to the marking on your Samsung product before attempting to install the product.

CAUTION

RISK OF ELECTRIC SHOCK DO NOT OPEN

CAUTION: TO REDUCE THE RISK OF ELECTRIC SHOCK, DO NOT REMOVE COVER (OR BACK). THERE ARE NO USER SERVICEABLE PARTS INSIDE. REFER ALL SERVICING TO QUALIFIED PERSONNEL.



This symbol indicates that high voltage is present inside. It is dangerous to make any kind of contact with any internal part of this product.



This symbol alerts you that important literature concerning operation and maintenance has been included with this product.

- The slots and openings in the cabinet and in the back or bottom are provided for necessary ventilation. To ensure reliable operation of this apparatus, and to protect it from overheating, these slots and openings must never be blocked or covered.
- Do not cover the slots and openings with a cloth or other materials.
- Do not block the slots and openings by placing this apparatus on a bed, sofa, rug or other similar surface.
- Do not place this apparatus in a confined space, such as a bookcase, or built-in cabinet, unless proper ventilation is provided.
- Do not place this apparatus near or over a radiator or heat resistor, or where it is exposed to direct sunlight.
- Do not place sources of heat on this apparatus, such as candles, ash trays, incense or other similar items.
- Do not place a water containing vessel on this apparatus, as this can result in a risk of fire or electric shock.
- Do not expose this apparatus to rain or place it near water (near a bathtub, washbowl, kitchen sink, or laundry tub, in a wet basement, or near a swimming pool etc.).
If this apparatus accidentally gets wet, unplug it and contact an authorized dealer immediately.
You can clean this apparatus with damp cloth when necessary, but be sure to unplug the apparatus first.
- Do not expose this apparatus to extreme temperature conditions or to extreme humidity conditions.
- This apparatus uses batteries. In your community there might be regulations that require you to dispose of these batteries properly under environmental considerations. Please contact your local authorities for disposal or recycling information.
- To cut off the power source, unplug this apparatus from the wall outlet.
- Do not overload wall outlets, extension cords or adaptors beyond their capacity, since this can result in fire or electric shock.
- Power-supply cords should be routed so that they are not likely to be walked on or pinched by items placed upon or against them, paying particular attention to cords at plug end, adaptors and the point where they exit from the appliance.
- To protect this apparatus from a lightning storm, or when it is left unattended and unused for long periods of time, unplug it from the wall outlet and disconnect the antenna or cable system.
This will prevent damage to the set due to lightning and power line surges.
- Before connecting the AC power cord to the DC adaptor outlet, make sure the voltage designation of the DC adaptor corresponds to the local electrical supply.
- Never insert anything metallic into the open parts of this apparatus. Doing so may create a danger of electric shock.
- To avoid electric shock, never touch the inside of this apparatus. Only a qualified technician should open this apparatus.
- Be sure to hold the plug, not the cord, when disconnecting this apparatus from an electric socket.
- Locate this apparatus near an easily accessible AC outlet.
- If this apparatus does not operate normally - in particular, if there are any unusual sounds or smells coming from it - unplug it immediately and contact an authorized dealer or service center.
- Unplug this apparatus from the AC outlet before any service.
- Be sure to pull the power plug out of the outlet if the TV is to remain unused or if you are to leave the house for an extended period of time (especially when children, elderly or disabled people will be left alone in the house).
- Accumulated dust can cause an electric shock, an electric leakage or a fire by causing the power cord to generate sparks and heat or the insulation to deteriorate.
- Be sure to contact an authorized service center, when installing your set in a location with heavy dust, high or low temperatures, high humidity, chemical substances and where it operates for 24 hours such as the airport, the train station etc. Failure to do so may cause serious damage to your set.

Wiring the Mains Power Supply Plug (UK Only)

IMPORTANT NOTICE

The mains lead on this equipment is supplied with a moulded plug incorporating a fuse. The value of the fuse is indicated on the pin face of the plug and, if it requires replacing, a fuse approved to BS11362 of the same rating must be used.

Never use the plug with the fuse cover omitted if the cover is detachable. If a replacement fuse cover is required, it must be of the same colour as the pin face of the plug. Replacement covers are available from your dealer.

If the fitted plug is not suitable for the power points in your house or the cable is not long enough to reach a power point, you should obtain a suitable safety approved extension lead or consult your dealer for assistance.

However, if there is no alternative but to cut off the plug, remove the fuse and then safely dispose of the plug. Do NOT connect the plug to a mains socket as there is a risk of shock hazard from the bared flexible cord.

IMPORTANT

The wires in the mains lead are coloured in accordance with the following code:

BLUE - NEUTRAL BROWN - LIVE

As these colours may not correspond to the coloured markings identifying the terminals in your plug, proceed as follows:

The wire coloured BLUE must be connected to the terminal marked with the letter N or coloured BLUE or BLACK. The wire coloured BROWN must be connected to the terminal marked with the letter L or coloured BROWN or RED.

WARNING:

DO NOT CONNECT EITHER WIRE TO THE EARTH TERMINAL, WHICH IS MARKED WITH THE LETTER E OR BY THE EARTH SYMBOL , OR COLOURED GREEN OR GREEN AND YELLOW.

Warranty Card



UNITED KINGDOM

This Samsung product is warranted for a period of twelve (12) months from the original date of purchase, against defective materials and workmanship. In the event that warranty service is required, you should return the product to the retailer from whom it was purchased. However, Samsung Authorised Dealers and Authorised Service Centres in other EC Countries will comply with the warranty on the terms issued to purchasers in the country concerned. In case of difficulty, details of our Authorised Service Centres are available from:

Samsung Electronics U.K. Ltd.
Customer Care Centre
PO Box 17243
Edinburgh, EH11 4YB
United Kingdom

Tel: 0845 SAMSUNG (7267864)(UK & Northern Ireland)

Tel: 0818 717 100 (Republic of Ireland Only)

Fax: 0845 650 8080

Web : www.samsung.com

WARRANTY CONDITIONS

1. The warranty is only valid if, when warranty service is required, the warranty card is fully and properly completed and is presented with the original invoice or sales slip or confirmation, and the serial number on the product has not been defaced.
2. Samsung's obligations are limited to the repair or, at its discretion, replacement of the product or the defective part.
3. Warranty repairs must be carried out by Authorised Samsung Dealers or Authorised Service Centres.
No re-imburement will be made for repairs carried out by non Samsung Dealers and, any such repair work and damage to the products caused by such repair work will not be covered by this warranty.
4. This product is not considered to be defective in materials nor workmanship by reason that it requires adaptation in order to conform to national or local technical or safety standards in force in any Country other than the one for which the product was originally designed and manufactured.

***This page is intentionally
left blank.***

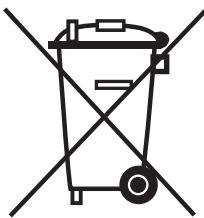

Correct Disposal of This Product (Waste Electrical & Electronic Equipment)

(Applicable in the European Union and other European countries with separate collection systems)

This marking shown on the product or its literature, indicates that it should not be disposed with other household wastes at the end of its working life.

To prevent possible harm to the environment or human health from uncontrolled waste disposal, please separate this from other types of wastes and recycle it responsibly to promote the sustainable reuse of material resources.

Household users should contact either the retailer where they purchased this product, or their local government office, for details of where and how they can take this item for environmentally safe recycling.

Business users should contact their supplier and check the terms and conditions of the purchase contract. This product should not be mixed with other commercial wastes for disposal.